



Full wwPDB X-ray Structure Validation Report ⓘ

Jun 22, 2024 – 11:52 PM EDT

PDB ID : 5FTT
Title : Octameric complex of Latrophilin 3 (Lec, Olf) , Unc5D (Ig, Ig2, TSP1) and FLRT2 (LRR)
Authors : Jackson, V.A.; Mehmood, S.; Chavent, M.; Roversi, P.; Carrasquero, M.; del Toro, D.; Seyit-Bremer, G.; Ranaivoson, F.M.; Comoletti, D.; Sansom, M.S.P.; Robinson, C.V.; Klein, R.; Seiradake, E.
Deposited on : 2016-01-15
Resolution : 3.40 Å(reported)

This is a Full wwPDB X-ray Structure Validation Report for a publicly released PDB entry.

We welcome your comments at validation@mail.wwpdb.org

A user guide is available at

<https://www.wwpdb.org/validation/2017/XrayValidationReportHelp>

with specific help available everywhere you see the ⓘ symbol.

The types of validation reports are described at

<http://www.wwpdb.org/validation/2017/FAQs#types>.

The following versions of software and data (see [references ⓘ](#)) were used in the production of this report:

MolProbity : 4.02b-467
Mogul : 1.8.5 (274361), CSD as541be (2020)
Xtrriage (Phenix) : 1.13
EDS : 2.37.1
Percentile statistics : 20191225.v01 (using entries in the PDB archive December 25th 2019)
Refmac : 5.8.0158
CCP4 : 7.0.044 (Gargrove)
Ideal geometry (proteins) : Engh & Huber (2001)
Ideal geometry (DNA, RNA) : Parkinson et al. (1996)
Validation Pipeline (wwPDB-VP) : 2.37.1

1 Overall quality at a glance

The following experimental techniques were used to determine the structure:

X-RAY DIFFRACTION

The reported resolution of this entry is 3.40 Å.

Percentile scores (ranging between 0-100) for global validation metrics of the entry are shown in the following graphic. The table shows the number of entries on which the scores are based.

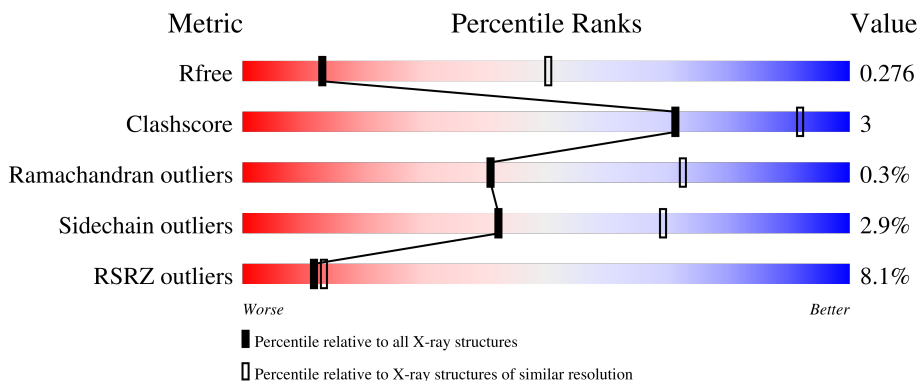



Metric	Whole archive (#Entries)	Similar resolution (#Entries, resolution range(Å))
R_{free}	130704	1026 (3.48-3.32)
Clashscore	141614	1055 (3.48-3.32)
Ramachandran outliers	138981	1038 (3.48-3.32)
Sidechain outliers	138945	1038 (3.48-3.32)
RSRZ outliers	127900	2173 (3.50-3.30)

The table below summarises the geometric issues observed across the polymeric chains and their fit to the electron density. The red, orange, yellow and green segments of the lower bar indicate the fraction of residues that contain outliers for ≥ 3 , 2, 1 and 0 types of geometric quality criteria respectively. A grey segment represents the fraction of residues that are not modelled. The numeric value for each fraction is indicated below the corresponding segment, with a dot representing fractions $\leq 5\%$. The upper red bar (where present) indicates the fraction of residues that have poor fit to the electron density. The numeric value is given above the bar.

Mol	Chain	Length	Quality of chain
1	A	285	
1	E	285	
2	B	339	
2	F	339	

Continued on next page...

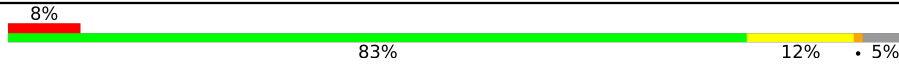
Continued from previous page...

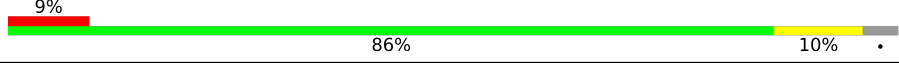
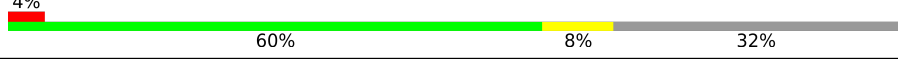
Mol	Chain	Length	Quality of chain
3	C	383	 8% 83% 12% 5%
3	D	383	 % 62% 7% 31%
3	G	383	 9% 86% 10% .
3	H	383	 4% 60% 8% 32%

2 Entry composition

There are 6 unique types of molecules in this entry. The entry contains 19610 atoms, of which 0 are hydrogens and 0 are deuteriums.

In the tables below, the ZeroOcc column contains the number of atoms modelled with zero occupancy, the AltConf column contains the number of residues with at least one atom in alternate conformation and the Trace column contains the number of residues modelled with at most 2 atoms.

- Molecule 1 is a protein called NETRIN RECEPTOR UNC5D.

Mol	Chain	Residues	Atoms					ZeroOcc	AltConf	Trace
			Total	C	N	O	S			
1	A	262	Total	C	N	O	S	0	0	0
			2060	1279	374	391	16			
1	E	259	Total	C	N	O	S	0	0	0
			2041	1268	371	386	16			

There are 18 discrepancies between the modelled and reference sequences:

Chain	Residue	Modelled	Actual	Comment	Reference
A	308	GLY	-	expression tag	UNP F1LW30
A	309	THR	-	expression tag	UNP F1LW30
A	310	LYS	-	expression tag	UNP F1LW30
A	311	HIS	-	expression tag	UNP F1LW30
A	312	HIS	-	expression tag	UNP F1LW30
A	313	HIS	-	expression tag	UNP F1LW30
A	314	HIS	-	expression tag	UNP F1LW30
A	315	HIS	-	expression tag	UNP F1LW30
A	316	HIS	-	expression tag	UNP F1LW30
E	308	GLY	-	expression tag	UNP F1LW30
E	309	THR	-	expression tag	UNP F1LW30
E	310	LYS	-	expression tag	UNP F1LW30
E	311	HIS	-	expression tag	UNP F1LW30
E	312	HIS	-	expression tag	UNP F1LW30
E	313	HIS	-	expression tag	UNP F1LW30
E	314	HIS	-	expression tag	UNP F1LW30
E	315	HIS	-	expression tag	UNP F1LW30
E	316	HIS	-	expression tag	UNP F1LW30

- Molecule 2 is a protein called LEUCINE-RICH REPEAT TRANSMEMBRANE PROTEIN FLRT2.

Mol	Chain	Residues	Atoms					ZeroOcc	AltConf	Trace
			Total	C	N	O	S			
2	B	326	Total	C	N	O	S	0	0	0
			2587	1634	461	478	14			

Continued on next page...

Continued from previous page...

Mol	Chain	Residues	Atoms					ZeroOcc	AltConf	Trace
			Total	C	N	O	S			
2	F	332	2641	1666	475	486	14	0	0	0

There are 22 discrepancies between the modelled and reference sequences:

Chain	Residue	Modelled	Actual	Comment	Reference
B	33	THR	-	expression tag	UNP Q8BLU0
B	34	GLY	-	expression tag	UNP Q8BLU0
B	363	ARG	-	expression tag	UNP Q8BLU0
B	364	THR	-	expression tag	UNP Q8BLU0
B	365	LYS	-	expression tag	UNP Q8BLU0
B	366	HIS	-	expression tag	UNP Q8BLU0
B	367	HIS	-	expression tag	UNP Q8BLU0
B	368	HIS	-	expression tag	UNP Q8BLU0
B	369	HIS	-	expression tag	UNP Q8BLU0
B	370	HIS	-	expression tag	UNP Q8BLU0
B	371	HIS	-	expression tag	UNP Q8BLU0
F	33	THR	-	expression tag	UNP Q8BLU0
F	34	GLY	-	expression tag	UNP Q8BLU0
F	363	ARG	-	expression tag	UNP Q8BLU0
F	364	THR	-	expression tag	UNP Q8BLU0
F	365	LYS	-	expression tag	UNP Q8BLU0
F	366	HIS	-	expression tag	UNP Q8BLU0
F	367	HIS	-	expression tag	UNP Q8BLU0
F	368	HIS	-	expression tag	UNP Q8BLU0
F	369	HIS	-	expression tag	UNP Q8BLU0
F	370	HIS	-	expression tag	UNP Q8BLU0
F	371	HIS	-	expression tag	UNP Q8BLU0

- Molecule 3 is a protein called ADHESION G PROTEIN-COUPLED RECEPTOR L3.

Mol	Chain	Residues	Atoms					ZeroOcc	AltConf	Trace
			Total	C	N	O	S			
3	C	365	2943	1867	485	575	16	0	0	0
3	D	263	2131	1360	351	415	5	0	0	0
3	G	368	2968	1883	491	578	16	0	0	0
3	H	261	2119	1354	349	411	5	0	0	0

There are 44 discrepancies between the modelled and reference sequences:

Chain	Residue	Modelled	Actual	Comment	Reference
C	90	THR	-	expression tag	UNP Q80TS3
C	91	GLY	-	expression tag	UNP Q80TS3
C	464	GLY	-	expression tag	UNP Q80TS3
C	465	THR	-	expression tag	UNP Q80TS3
C	466	LYS	-	expression tag	UNP Q80TS3
C	467	HIS	-	expression tag	UNP Q80TS3
C	468	HIS	-	expression tag	UNP Q80TS3
C	469	HIS	-	expression tag	UNP Q80TS3
C	470	HIS	-	expression tag	UNP Q80TS3
C	471	HIS	-	expression tag	UNP Q80TS3
C	472	HIS	-	expression tag	UNP Q80TS3
D	90	THR	-	expression tag	UNP Q80TS3
D	91	GLY	-	expression tag	UNP Q80TS3
D	464	GLY	-	expression tag	UNP Q80TS3
D	465	THR	-	expression tag	UNP Q80TS3
D	466	LYS	-	expression tag	UNP Q80TS3
D	467	HIS	-	expression tag	UNP Q80TS3
D	468	HIS	-	expression tag	UNP Q80TS3
D	469	HIS	-	expression tag	UNP Q80TS3
D	470	HIS	-	expression tag	UNP Q80TS3
D	471	HIS	-	expression tag	UNP Q80TS3
D	472	HIS	-	expression tag	UNP Q80TS3
G	90	THR	-	expression tag	UNP Q80TS3
G	91	GLY	-	expression tag	UNP Q80TS3
G	464	GLY	-	expression tag	UNP Q80TS3
G	465	THR	-	expression tag	UNP Q80TS3
G	466	LYS	-	expression tag	UNP Q80TS3
G	467	HIS	-	expression tag	UNP Q80TS3
G	468	HIS	-	expression tag	UNP Q80TS3
G	469	HIS	-	expression tag	UNP Q80TS3
G	470	HIS	-	expression tag	UNP Q80TS3
G	471	HIS	-	expression tag	UNP Q80TS3
G	472	HIS	-	expression tag	UNP Q80TS3
H	90	THR	-	expression tag	UNP Q80TS3
H	91	GLY	-	expression tag	UNP Q80TS3
H	464	GLY	-	expression tag	UNP Q80TS3
H	465	THR	-	expression tag	UNP Q80TS3
H	466	LYS	-	expression tag	UNP Q80TS3
H	467	HIS	-	expression tag	UNP Q80TS3
H	468	HIS	-	expression tag	UNP Q80TS3
H	469	HIS	-	expression tag	UNP Q80TS3
H	470	HIS	-	expression tag	UNP Q80TS3
H	471	HIS	-	expression tag	UNP Q80TS3

Continued on next page...

Continued from previous page...

Chain	Residue	Modelled	Actual	Comment	Reference
H	472	HIS	-	expression tag	UNP Q80TS3

- Molecule 4 is 2-acetamido-2-deoxy-beta-D-glucopyranose (three-letter code: NAG) (formula: $C_8H_{15}NO_6$).

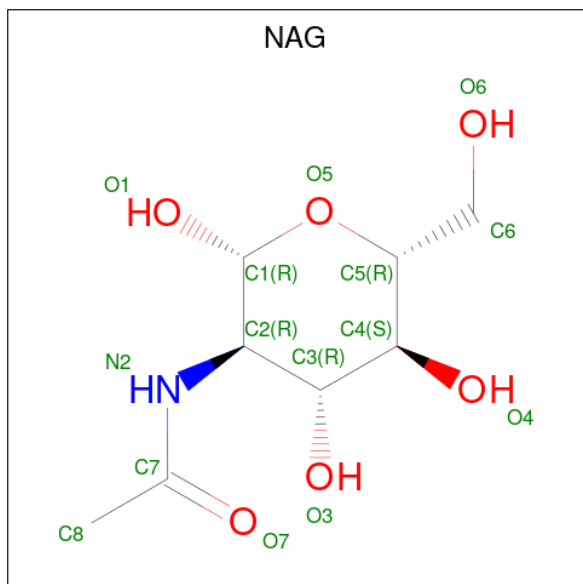

Mol	Chain	Residues	Atoms				ZeroOcc	AltConf
			Total	C	N	O		
4	A	1	Total	C	N	O	0	0
			14	8	1	5		
4	A	1	Total	C	N	O	0	0
			14	8	1	5		
4	B	1	Total	C	N	O	14	0
			14	8	1	5		
4	C	1	Total	C	N	O	14	0
			14	8	1	5		
4	E	1	Total	C	N	O	0	0
			14	8	1	5		
4	E	1	Total	C	N	O	0	0
			14	8	1	5		
4	F	1	Total	C	N	O	14	0
			14	8	1	5		
4	G	1	Total	C	N	O	14	0
			14	8	1	5		

- Molecule 5 is SODIUM ION (three-letter code: NA) (formula: Na).

Mol	Chain	Residues	Atoms	ZeroOcc	AltConf
5	C	1	Total Na 1 1	0	0
5	D	1	Total Na 1 1	0	0
5	G	1	Total Na 1 1	0	0
5	H	1	Total Na 1 1	0	0

- Molecule 6 is CALCIUM ION (three-letter code: CA) (formula: Ca).

Mol	Chain	Residues	Atoms	ZeroOcc	AltConf
6	C	1	Total Ca 1 1	0	0
6	D	1	Total Ca 1 1	0	0
6	G	1	Total Ca 1 1	0	0
6	H	1	Total Ca 1 1	0	0

3 Residue-property plots [i](#)

These plots are drawn for all protein, RNA, DNA and oligosaccharide chains in the entry. The first graphic for a chain summarises the proportions of the various outlier classes displayed in the second graphic. The second graphic shows the sequence view annotated by issues in geometry and electron density. Residues are color-coded according to the number of geometric quality criteria for which they contain at least one outlier: green = 0, yellow = 1, orange = 2 and red = 3 or more. A red dot above a residue indicates a poor fit to the electron density ($RSRZ > 2$). Stretches of 2 or more consecutive residues without any outlier are shown as a green connector. Residues present in the sample, but not in the model, are shown in grey.

- Molecule 1: NETRIN RECEPTOR UNC5D

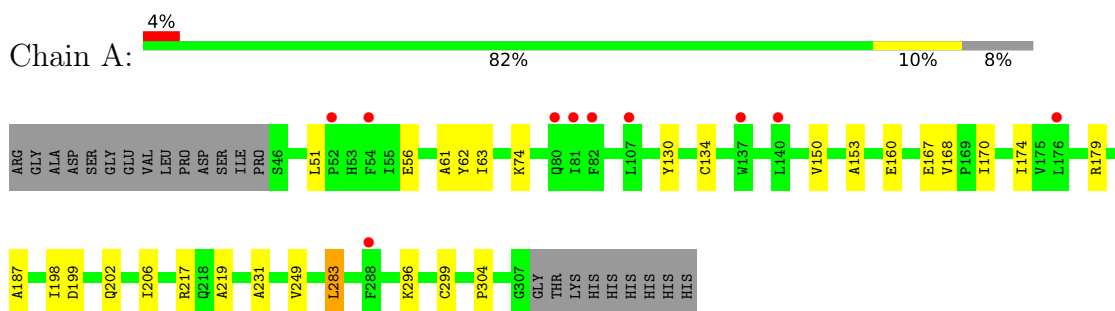

- Molecule 1: NETRIN RECEPTOR UNC5D

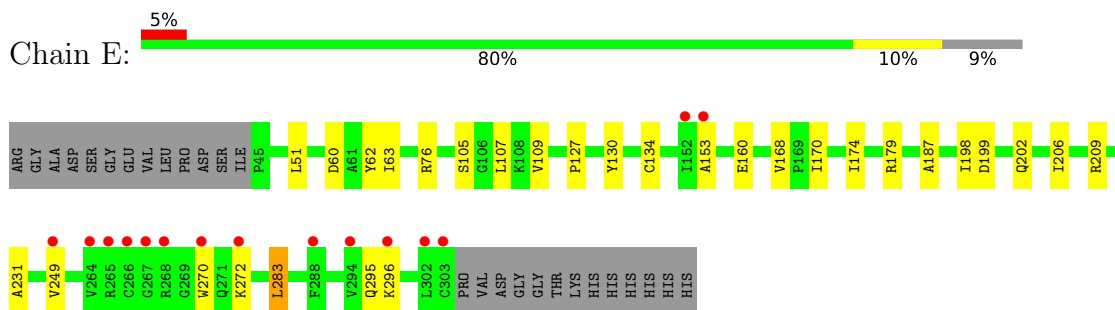

- Molecule 2: LEUCINE-RICH REPEAT TRANSMEMBRANE PROTEIN FLRT2

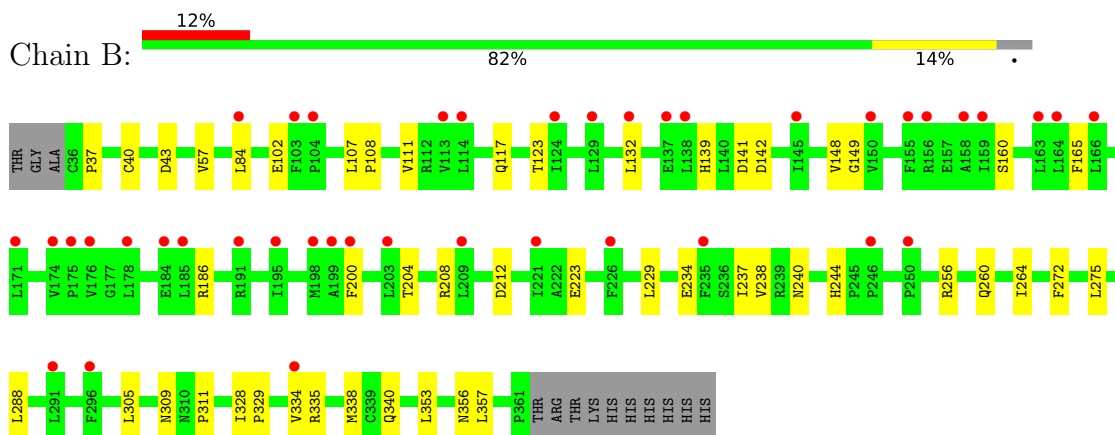

- Molecule 2: LEUCINE-RICH REPEAT TRANSMEMBRANE PROTEIN FLRT2

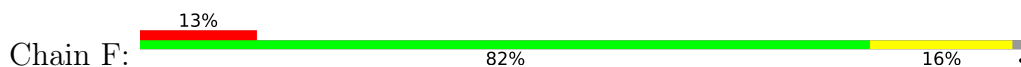

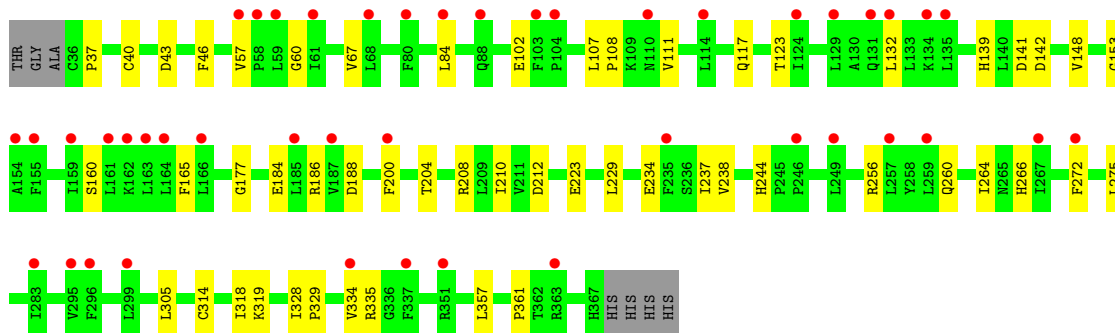

• Molecule 3: ADHESION G PROTEIN-COUPLED RECEPTOR L3

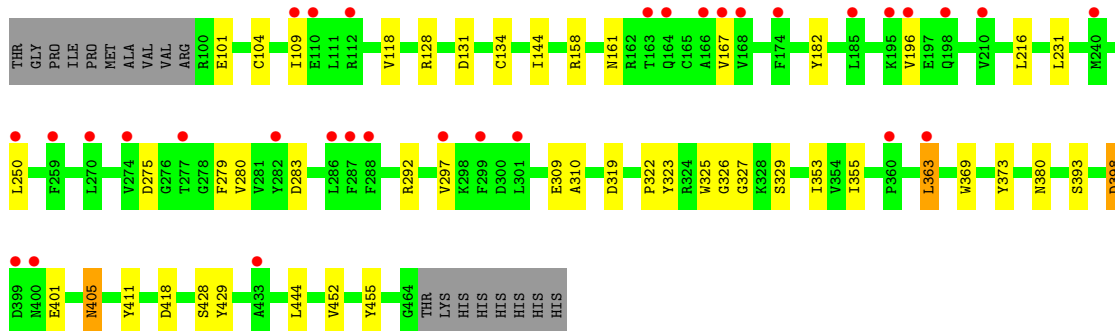
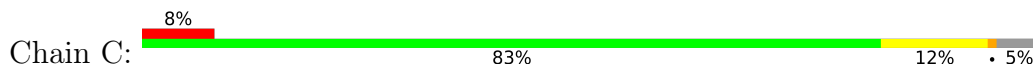

• Molecule 3: ADHESION G PROTEIN-COUPLED RECEPTOR L3

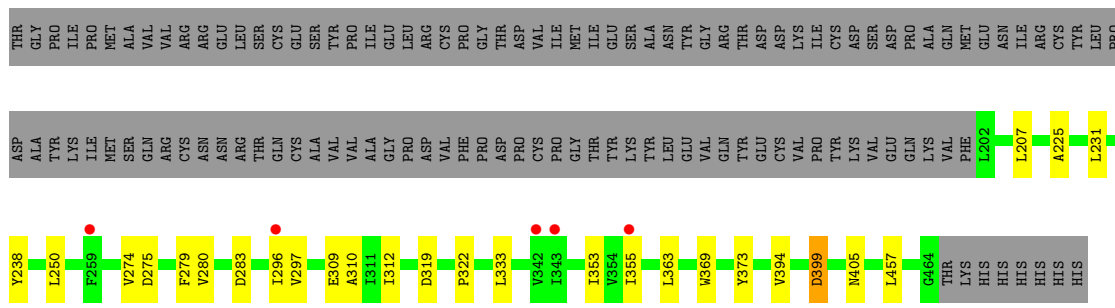

• Molecule 3: ADHESION G PROTEIN-COUPLED RECEPTOR L3

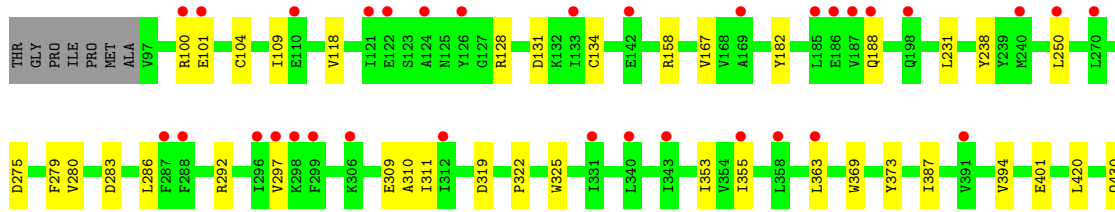
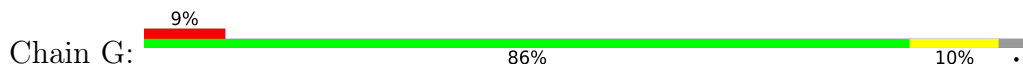

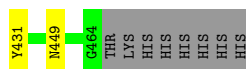

● Molecule 3: ADHESION G PROTEIN-COUPLED RECEPTOR L3

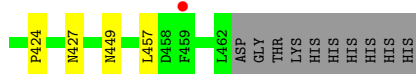
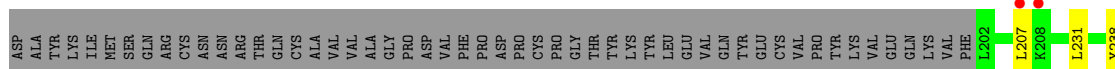

4 Data and refinement statistics

Property	Value	Source
Space group	C 1 2 1	Depositor
Cell constants a, b, c, α , β , γ	231.96Å 141.49Å 151.49Å 90.00° 117.94° 90.00°	Depositor
Resolution (Å)	133.83 – 3.40 116.43 – 3.40	Depositor EDS
% Data completeness (in resolution range)	98.5 (133.83-3.40) 98.5 (116.43-3.40)	Depositor EDS
R_{merge}	0.15	Depositor
R_{sym}	(Not available)	Depositor
$\langle I/\sigma(I) \rangle$ ¹	1.23 (at 3.41Å)	Xtrriage
Refinement program	BUSTER 2.10.2	Depositor
R, R_{free}	0.225 , 0.245 0.249 , 0.276	Depositor DCC
R_{free} test set	2832 reflections (4.83%)	wwPDB-VP
Wilson B-factor (Å ²)	121.2	Xtrriage
Anisotropy	0.167	Xtrriage
Bulk solvent k_{sol} (e/Å ³), B_{sol} (Å ²)	0.26 , 115.2	EDS
L-test for twinning ²	$\langle L \rangle = 0.45$, $\langle L^2 \rangle = 0.27$	Xtrriage
Estimated twinning fraction	No twinning to report.	Xtrriage
F_o, F_c correlation	0.92	EDS
Total number of atoms	19610	wwPDB-VP
Average B, all atoms (Å ²)	185.0	wwPDB-VP

Xtrriage's analysis on translational NCS is as follows: *The largest off-origin peak in the Patterson function is 3.65% of the height of the origin peak. No significant pseudotranslation is detected.*

¹Intensities estimated from amplitudes.

²Theoretical values of $\langle |L| \rangle$, $\langle L^2 \rangle$ for acentric reflections are 0.5, 0.333 respectively for untwinned datasets, and 0.375, 0.2 for perfectly twinned datasets.

5 Model quality [i](#)

5.1 Standard geometry [i](#)

Bond lengths and bond angles in the following residue types are not validated in this section: CA, NAG, NA

The Z score for a bond length (or angle) is the number of standard deviations the observed value is removed from the expected value. A bond length (or angle) with $|Z| > 5$ is considered an outlier worth inspection. RMSZ is the root-mean-square of all Z scores of the bond lengths (or angles).

Mol	Chain	Bond lengths		Bond angles	
		RMSZ	# Z >5	RMSZ	# Z >5
1	A	0.35	0/2109	0.54	0/2863
1	E	0.34	0/2090	0.54	0/2836
2	B	0.38	0/2637	0.58	0/3583
2	F	0.38	0/2694	0.60	0/3661
3	C	0.38	0/3021	0.60	0/4115
3	D	0.37	0/2189	0.56	0/2982
3	G	0.38	0/3046	0.57	0/4149
3	H	0.37	0/2178	0.58	0/2969
All	All	0.37	0/19964	0.57	0/27158

There are no bond length outliers.

There are no bond angle outliers.

There are no chirality outliers.

There are no planarity outliers.

5.2 Too-close contacts [i](#)

In the following table, the Non-H and H(model) columns list the number of non-hydrogen atoms and hydrogen atoms in the chain respectively. The H(added) column lists the number of hydrogen atoms added and optimized by MolProbity. The Clashes column lists the number of clashes within the asymmetric unit, whereas Symm-Clashes lists symmetry-related clashes.

Mol	Chain	Non-H	H(model)	H(added)	Clashes	Symm-Clashes
1	A	2060	0	1970	12	0
1	E	2041	0	1955	16	0
2	B	2587	0	2593	22	0
2	F	2641	0	2648	25	0
3	C	2943	0	2786	21	0

Continued on next page...

Continued from previous page...

Mol	Chain	Non-H	H(model)	H(added)	Clashes	Symm-Clashes
3	D	2131	0	2015	14	0
3	G	2968	0	2817	20	0
3	H	2119	0	2009	15	0
4	A	28	0	26	0	0
4	B	14	0	13	0	0
4	C	14	0	13	0	0
4	E	28	0	26	0	0
4	F	14	0	13	0	0
4	G	14	0	13	0	0
5	C	1	0	0	0	0
5	D	1	0	0	0	0
5	G	1	0	0	0	0
5	H	1	0	0	0	0
6	C	1	0	0	0	0
6	D	1	0	0	0	0
6	G	1	0	0	0	0
6	H	1	0	0	0	0
All	All	19610	0	18897	134	0

The all-atom clashscore is defined as the number of clashes found per 1000 atoms (including hydrogen atoms). The all-atom clashscore for this structure is 3.

All (134) close contacts within the same asymmetric unit are listed below, sorted by their clash magnitude.

Atom-1	Atom-2	Interatomic distance (Å)	Clash overlap (Å)
3:C:393:SER:HA	3:C:405:ASN:H	1.49	0.77
3:G:310:ALA:HB2	3:G:363:LEU:HB3	1.77	0.66
2:B:200:PHE:HB3	2:B:229:LEU:HD11	1.79	0.64
3:D:310:ALA:HB2	3:D:363:LEU:HB3	1.78	0.64
2:F:200:PHE:HB3	2:F:229:LEU:HD11	1.79	0.64
3:H:310:ALA:HB2	3:H:363:LEU:HB3	1.78	0.64
3:D:225:ALA:HB3	3:D:279:PHE:HD2	1.63	0.62
3:D:297:VAL:HG22	3:D:309:GLU:HG3	1.82	0.61
2:F:153:GLY:HA2	2:F:177:GLY:HA3	1.82	0.60
3:H:406:LYS:HG2	3:H:424:PRO:HA	1.84	0.60
3:C:398:ASP:HB3	3:C:401:GLU:HB2	1.83	0.60
2:F:208:ARG:HG2	2:F:234:GLU:HB3	1.84	0.59
2:B:208:ARG:HG2	2:B:234:GLU:HB3	1.85	0.58
1:A:296:LYS:HE3	1:E:51:LEU:HD21	1.86	0.58
3:C:310:ALA:HB2	3:C:363:LEU:HB2	1.84	0.58
3:C:411:TYR:HD1	3:C:418:ASP:HB3	1.69	0.58

Continued on next page...

Continued from previous page...

Atom-1	Atom-2	Interatomic distance (Å)	Clash overlap (Å)
3:C:297:VAL:HG22	3:C:309:GLU:HG3	1.87	0.56
2:B:186:ARG:HH21	2:B:208:ARG:HH12	1.53	0.56
2:F:102:GLU:HG2	2:F:123:THR:HB	1.88	0.56
3:H:296:ILE:HG12	3:H:312:ILE:HD11	1.88	0.56
2:B:335:ARG:HE	3:D:399:ASP:HA	1.73	0.54
3:H:394:VAL:HG11	3:H:401:GLU:HA	1.89	0.54
2:F:335:ARG:HD3	3:H:401:GLU:HB2	1.90	0.53
1:A:217:ARG:HG2	1:E:209:ARG:HH12	1.73	0.53
3:H:207:LEU:HD11	3:H:457:LEU:HD22	1.90	0.53
3:G:238:TYR:HB3	3:G:250:LEU:HD11	1.92	0.52
1:A:160:GLU:HB3	1:A:179:ARG:HB3	1.92	0.52
1:A:62:TYR:HB3	1:A:153:ALA:HB2	1.91	0.51
2:B:238:VAL:HG12	2:B:260:GLN:H	1.76	0.51
1:E:160:GLU:HB3	1:E:179:ARG:HB3	1.92	0.51
2:F:238:VAL:HG12	2:F:260:GLN:H	1.76	0.51
1:A:51:LEU:HD23	1:E:296:LYS:H	1.75	0.51
2:B:212:ASP:HB3	2:B:238:VAL:H	1.76	0.51
2:B:328:ILE:HG13	2:B:329:PRO:HD2	1.93	0.50
3:D:207:LEU:HD11	3:D:457:LEU:HD22	1.92	0.50
1:E:199:ASP:HB3	1:E:202:GLN:HB2	1.92	0.50
1:A:199:ASP:HB3	1:A:202:GLN:HB2	1.93	0.50
2:F:212:ASP:HB3	2:F:238:VAL:H	1.76	0.50
2:B:234:GLU:HG3	2:B:256:ARG:HB2	1.94	0.50
3:G:104:CYS:HB3	3:G:182:TYR:HE1	1.77	0.50
2:F:139:HIS:HA	2:F:165:PHE:HB2	1.94	0.49
3:G:231:LEU:HD22	3:G:283:ASP:HB2	1.94	0.49
2:B:139:HIS:HA	2:B:165:PHE:HB2	1.95	0.49
2:F:234:GLU:HG3	2:F:256:ARG:HB2	1.94	0.49
3:G:128:ARG:HH22	3:G:134:CYS:HB3	1.77	0.49
3:C:231:LEU:HD22	3:C:283:ASP:HB2	1.94	0.49
1:E:62:TYR:HB3	1:E:153:ALA:HB2	1.95	0.49
3:G:297:VAL:HG22	3:G:309:GLU:HG3	1.95	0.49
2:F:186:ARG:HH21	2:F:208:ARG:HH12	1.60	0.49
3:C:101:GLU:HB3	3:C:109:ILE:HD11	1.94	0.48
2:F:117:GLN:HE21	3:G:292:ARG:HE	1.60	0.48
2:B:102:GLU:HG2	2:B:123:THR:HB	1.95	0.48
2:B:353:LEU:HD13	2:B:356:ASN:HA	1.95	0.48
3:D:238:TYR:HB3	3:D:250:LEU:HD11	1.94	0.48
3:H:231:LEU:HD22	3:H:283:ASP:HB2	1.95	0.48
2:B:311:PRO:HA	2:B:340:GLN:HG3	1.95	0.48
3:H:353:ILE:HD12	3:H:373:TYR:HB3	1.96	0.48

Continued on next page...

Continued from previous page...

Atom-1	Atom-2	Interatomic distance (Å)	Clash overlap (Å)
2:B:305:LEU:HB3	2:B:334:VAL:HG22	1.95	0.48
3:D:231:LEU:HD22	3:D:283:ASP:HB2	1.95	0.48
3:H:280:VAL:HG12	3:H:287:PHE:HB2	1.96	0.48
2:F:319:LYS:HG3	2:F:361:PRO:HG3	1.95	0.47
3:G:353:ILE:HD12	3:G:373:TYR:HB3	1.96	0.47
2:B:117:GLN:HE21	3:C:292:ARG:HE	1.62	0.47
3:D:353:ILE:HD12	3:D:373:TYR:HB3	1.96	0.47
2:F:305:LEU:HB3	2:F:334:VAL:HG22	1.95	0.47
2:F:314:CYS:HA	2:F:318:ILE:HG12	1.96	0.47
3:G:100:ARG:HH11	3:G:188:GLN:HE21	1.61	0.47
1:E:76:ARG:HH12	1:E:105:SER:HB2	1.80	0.46
3:H:297:VAL:HG22	3:H:309:GLU:HG3	1.97	0.46
3:C:104:CYS:HB3	3:C:182:TYR:HE1	1.79	0.46
3:G:250:LEU:HD22	3:G:286:LEU:HD22	1.97	0.46
3:C:353:ILE:HD12	3:C:373:TYR:HB3	1.96	0.46
2:F:108:PRO:HB2	2:F:111:VAL:HG23	1.97	0.46
3:G:355:ILE:HG13	3:G:369:TRP:HB2	1.98	0.46
3:C:355:ILE:HG13	3:C:369:TRP:HB2	1.97	0.46
3:H:355:ILE:HG13	3:H:369:TRP:HB2	1.98	0.46
3:H:238:TYR:HB3	3:H:250:LEU:HD11	1.97	0.46
2:B:108:PRO:HB2	2:B:111:VAL:HG23	1.97	0.46
3:D:355:ILE:HG13	3:D:369:TRP:HB2	1.98	0.46
2:B:149:GLY:HA2	1:E:270:TRP:HH2	1.81	0.46
3:G:158:ARG:HE	3:G:167:VAL:HG22	1.81	0.45
1:A:56:GLU:HB2	1:A:74:LYS:HB2	1.98	0.45
1:A:61:ALA:HB3	1:A:150:VAL:HG22	1.98	0.45
1:A:249:VAL:HB	1:A:283:LEU:HB2	1.96	0.45
3:C:325:TRP:CZ3	3:C:327:GLY:HA3	2.51	0.45
1:E:249:VAL:HB	1:E:283:LEU:HB2	1.98	0.45
3:C:322:PRO:HG2	3:C:326:GLY:HA2	1.99	0.44
2:F:272:PHE:HA	2:F:275:LEU:HD12	1.99	0.44
2:F:328:ILE:HG13	2:F:329:PRO:HD2	1.99	0.44
3:C:158:ARG:HE	3:C:167:VAL:HG22	1.82	0.44
3:D:394:VAL:H	3:D:405:ASN:ND2	2.16	0.44
3:D:274:VAL:HG11	3:D:279:PHE:CE1	2.53	0.44
2:B:244:HIS:HA	2:B:264:ILE:HG23	1.99	0.44
3:D:319:ASP:HA	3:D:322:PRO:HG3	1.99	0.44
3:D:296:ILE:HG12	3:D:312:ILE:HD11	1.99	0.44
2:F:57:VAL:HG11	2:F:84:LEU:HD13	2.00	0.44
1:E:76:ARG:HD2	1:E:107:LEU:HB3	2.00	0.44
2:F:184:GLU:HG3	2:F:208:ARG:HB2	2.00	0.43

Continued on next page...

Continued from previous page...

Atom-1	Atom-2	Interatomic distance (Å)	Clash overlap (Å)
3:G:128:ARG:HH11	3:G:131:ASP:HA	1.84	0.43
2:B:37:PRO:HG2	2:B:40:CYS:HB3	2.00	0.43
2:B:272:PHE:HA	2:B:275:LEU:HD12	2.00	0.43
2:B:57:VAL:HG11	2:B:84:LEU:HD13	2.00	0.43
3:C:444:LEU:HB2	3:C:455:TYR:HB2	2.00	0.43
2:F:37:PRO:HG2	2:F:40:CYS:HB3	2.00	0.43
1:E:187:ALA:HB1	1:E:231:ALA:HB1	2.01	0.43
3:G:319:ASP:HA	3:G:322:PRO:HG3	2.00	0.43
1:E:168:VAL:HG11	1:E:174:ILE:HG12	2.00	0.43
3:H:319:ASP:HA	3:H:322:PRO:HG3	1.99	0.43
3:G:394:VAL:HG23	3:G:401:GLU:HB2	2.00	0.42
3:C:161:ASN:HB3	3:C:196:VAL:HG12	2.01	0.42
3:C:216:LEU:HD13	3:C:452:VAL:HG12	2.00	0.42
3:C:319:ASP:HA	3:C:322:PRO:HG3	2.00	0.42
2:B:107:LEU:HB2	2:B:132:LEU:HD11	2.00	0.42
2:F:46:PHE:HD1	2:F:67:VAL:HB	1.84	0.42
3:H:274:VAL:HG11	3:H:279:PHE:CE2	2.55	0.42
3:C:128:ARG:HH22	3:C:134:CYS:HB2	1.85	0.42
3:G:101:GLU:HB3	3:G:109:ILE:HD11	2.02	0.42
1:A:168:VAL:HG11	1:A:174:ILE:HG12	2.02	0.42
1:A:187:ALA:HB1	1:A:231:ALA:HB1	2.01	0.42
3:G:431:TYR:H	3:G:449:ASN:HB2	1.85	0.42
1:E:76:ARG:HD3	1:E:109:VAL:HG22	2.02	0.41
2:F:244:HIS:HA	2:F:264:ILE:HG23	2.01	0.41
2:B:212:ASP:HA	2:B:240:ASN:HD21	1.85	0.41
2:F:188:ASP:HB3	2:F:210:ILE:HG22	2.02	0.41
1:A:51:LEU:HD21	1:E:295:GLN:HA	2.03	0.41
1:E:127:PRO:HB2	3:G:311:ILE:HD11	2.03	0.41
3:D:274:VAL:HG11	3:D:279:PHE:HE1	1.85	0.41
1:E:272:LYS:HZ3	1:E:296:LYS:HD3	1.85	0.41
3:G:325:TRP:HB2	3:G:431:TYR:CZ	2.56	0.41
2:F:107:LEU:HB2	2:F:132:LEU:HD11	2.02	0.40
3:C:128:ARG:HH11	3:C:131:ASP:HA	1.86	0.40
3:H:296:ILE:HG12	3:H:312:ILE:CD1	2.50	0.40
3:C:323:TYR:H	3:C:329:SER:HB2	1.86	0.40
2:F:117:GLN:NE2	3:G:292:ARG:HE	2.19	0.40

There are no symmetry-related clashes.

5.3 Torsion angles [i](#)

5.3.1 Protein backbone [i](#)

In the following table, the Percentiles column shows the percent Ramachandran outliers of the chain as a percentile score with respect to all X-ray entries followed by that with respect to entries of similar resolution.

The Analysed column shows the number of residues for which the backbone conformation was analysed, and the total number of residues.

Mol	Chain	Analysed	Favoured	Allowed	Outliers	Percentiles	
1	A	260/285 (91%)	247 (95%)	10 (4%)	3 (1%)	13	41
1	E	257/285 (90%)	246 (96%)	10 (4%)	1 (0%)	34	67
2	B	322/339 (95%)	280 (87%)	40 (12%)	2 (1%)	25	57
2	F	330/339 (97%)	291 (88%)	37 (11%)	2 (1%)	25	57
3	C	363/383 (95%)	332 (92%)	31 (8%)	0	100	100
3	D	259/383 (68%)	234 (90%)	25 (10%)	0	100	100
3	G	366/383 (96%)	333 (91%)	33 (9%)	0	100	100
3	H	259/383 (68%)	236 (91%)	23 (9%)	0	100	100
All	All	2416/2780 (87%)	2199 (91%)	209 (9%)	8 (0%)	41	72

All (8) Ramachandran outliers are listed below:

Mol	Chain	Res	Type
1	A	304	PRO
2	B	223	GLU
1	A	130	TYR
1	A	219	ALA
1	E	130	TYR
2	F	223	GLU
2	B	309	ASN
2	F	60	GLY

5.3.2 Protein sidechains [i](#)

In the following table, the Percentiles column shows the percent sidechain outliers of the chain as a percentile score with respect to all X-ray entries followed by that with respect to entries of similar resolution.

The Analysed column shows the number of residues for which the sidechain conformation was analysed, and the total number of residues.

Mol	Chain	Analysed	Rotameric	Outliers	Percentiles	
1	A	225/244 (92%)	217 (96%)	8 (4%)	35	63
1	E	223/244 (91%)	216 (97%)	7 (3%)	40	68
2	B	297/308 (96%)	287 (97%)	10 (3%)	37	65
2	F	303/308 (98%)	294 (97%)	9 (3%)	41	68
3	C	324/340 (95%)	312 (96%)	12 (4%)	34	62
3	D	231/340 (68%)	227 (98%)	4 (2%)	60	80
3	G	327/340 (96%)	320 (98%)	7 (2%)	53	76
3	H	230/340 (68%)	224 (97%)	6 (3%)	46	72
All	All	2160/2464 (88%)	2097 (97%)	63 (3%)	42	69

All (63) residues with a non-rotameric sidechain are listed below:

Mol	Chain	Res	Type
1	A	63	ILE
1	A	134	CYS
1	A	167	GLU
1	A	170	ILE
1	A	198	ILE
1	A	206	ILE
1	A	283	LEU
1	A	299	CYS
2	B	43	ASP
2	B	141	ASP
2	B	142	ASP
2	B	148	VAL
2	B	160	SER
2	B	204	THR
2	B	237	ILE
2	B	288	LEU
2	B	338	MET
2	B	357	LEU
3	C	118	VAL
3	C	144	ILE
3	C	250	LEU
3	C	275	ASP
3	C	279	PHE
3	C	280	VAL
3	C	363	LEU
3	C	380	ASN
3	C	398	ASP

Continued on next page...

Continued from previous page...

Mol	Chain	Res	Type
3	C	405	ASN
3	C	428	SER
3	C	429	TYR
3	D	275	ASP
3	D	280	VAL
3	D	333	LEU
3	D	399	ASP
1	E	60	ASP
1	E	63	ILE
1	E	134	CYS
1	E	170	ILE
1	E	198	ILE
1	E	206	ILE
1	E	283	LEU
2	F	43	ASP
2	F	141	ASP
2	F	142	ASP
2	F	148	VAL
2	F	160	SER
2	F	204	THR
2	F	237	ILE
2	F	266	HIS
2	F	357	LEU
3	G	118	VAL
3	G	275	ASP
3	G	279	PHE
3	G	280	VAL
3	G	387	ILE
3	G	420	LEU
3	G	430	GLN
3	H	275	ASP
3	H	280	VAL
3	H	380	ASN
3	H	420	LEU
3	H	427	ASN
3	H	449	ASN

Sometimes sidechains can be flipped to improve hydrogen bonding and reduce clashes. All (6) such sidechains are listed below:

Mol	Chain	Res	Type
3	C	415	GLN
3	D	212	GLN

Continued on next page...

Continued from previous page...

Mol	Chain	Res	Type
3	D	415	GLN
3	G	188	GLN
3	G	415	GLN
3	H	415	GLN

5.3.3 RNA [i](#)

There are no RNA molecules in this entry.

5.4 Non-standard residues in protein, DNA, RNA chains [i](#)

There are no non-standard protein/DNA/RNA residues in this entry.

5.5 Carbohydrates [i](#)

There are no monosaccharides in this entry.

5.6 Ligand geometry [i](#)

Of 16 ligands modelled in this entry, 8 are monoatomic - leaving 8 for Mogul analysis.

In the following table, the Counts columns list the number of bonds (or angles) for which Mogul statistics could be retrieved, the number of bonds (or angles) that are observed in the model and the number of bonds (or angles) that are defined in the Chemical Component Dictionary. The Link column lists molecule types, if any, to which the group is linked. The Z score for a bond length (or angle) is the number of standard deviations the observed value is removed from the expected value. A bond length (or angle) with $|Z| > 2$ is considered an outlier worth inspection. RMSZ is the root-mean-square of all Z scores of the bond lengths (or angles).

Mol	Type	Chain	Res	Link	Bond lengths			Bond angles		
					Counts	RMSZ	$\# Z > 2$	Counts	RMSZ	$\# Z > 2$
4	NAG	C	1465	3	14,14,15	0.58	0	17,19,21	1.04	1 (5%)
4	NAG	B	1362	2	14,14,15	0.46	0	17,19,21	1.15	2 (11%)
4	NAG	E	1304	1	14,14,15	0.53	0	17,19,21	1.10	2 (11%)
4	NAG	A	1309	1	14,14,15	0.52	0	17,19,21	1.16	2 (11%)
4	NAG	G	1465	3	14,14,15	0.59	0	17,19,21	0.89	1 (5%)
4	NAG	E	1305	1	14,14,15	0.51	0	17,19,21	1.17	2 (11%)
4	NAG	A	1308	1	14,14,15	0.54	0	17,19,21	1.10	2 (11%)
4	NAG	F	1368	2	14,14,15	0.45	0	17,19,21	1.15	2 (11%)

In the following table, the Chirals column lists the number of chiral outliers, the number of chiral centers analysed, the number of these observed in the model and the number defined in the Chemical Component Dictionary. Similar counts are reported in the Torsion and Rings columns. '-' means no outliers of that kind were identified.

Mol	Type	Chain	Res	Link	Chirals	Torsions	Rings
4	NAG	C	1465	3	-	4/6/23/26	0/1/1/1
4	NAG	B	1362	2	-	0/6/23/26	0/1/1/1
4	NAG	E	1304	1	-	0/6/23/26	0/1/1/1
4	NAG	A	1309	1	-	0/6/23/26	0/1/1/1
4	NAG	G	1465	3	-	3/6/23/26	0/1/1/1
4	NAG	E	1305	1	-	0/6/23/26	0/1/1/1
4	NAG	A	1308	1	-	0/6/23/26	0/1/1/1
4	NAG	F	1368	2	-	0/6/23/26	0/1/1/1

There are no bond length outliers.

All (14) bond angle outliers are listed below:

Mol	Chain	Res	Type	Atoms	Z	Observed(°)	Ideal(°)
4	E	1305	NAG	C4-C3-C2	-2.47	107.40	111.02
4	A	1309	NAG	C4-C3-C2	-2.36	107.56	111.02
4	B	1362	NAG	C4-C3-C2	-2.32	107.62	111.02
4	F	1368	NAG	C4-C3-C2	-2.32	107.62	111.02
4	E	1304	NAG	C4-C3-C2	-2.26	107.70	111.02
4	A	1308	NAG	C4-C3-C2	-2.20	107.80	111.02
4	C	1465	NAG	C4-C3-C2	-2.20	107.80	111.02
4	B	1362	NAG	C8-C7-N2	2.18	119.80	116.10
4	A	1308	NAG	C8-C7-N2	2.16	119.76	116.10
4	F	1368	NAG	C8-C7-N2	2.16	119.76	116.10
4	E	1305	NAG	C8-C7-N2	2.15	119.74	116.10
4	G	1465	NAG	C4-C3-C2	-2.12	107.91	111.02
4	E	1304	NAG	C8-C7-N2	2.12	119.69	116.10
4	A	1309	NAG	C8-C7-N2	2.12	119.68	116.10

There are no chirality outliers.

All (7) torsion outliers are listed below:

Mol	Chain	Res	Type	Atoms
4	C	1465	NAG	C4-C5-C6-O6
4	G	1465	NAG	C4-C5-C6-O6
4	C	1465	NAG	O5-C5-C6-O6
4	G	1465	NAG	O5-C5-C6-O6
4	C	1465	NAG	C1-C2-N2-C7

Continued on next page...

Continued from previous page...

Mol	Chain	Res	Type	Atoms
4	G	1465	NAG	C3-C2-N2-C7
4	C	1465	NAG	C3-C2-N2-C7

There are no ring outliers.

No monomer is involved in short contacts.

5.7 Other polymers [i](#)

There are no such residues in this entry.

5.8 Polymer linkage issues [i](#)

The following chains have linkage breaks:

Mol	Chain	Number of breaks
2	B	1
3	D	1

All chain breaks are listed below:

Model	Chain	Residue-1	Atom-1	Residue-2	Atom-2	Distance (Å)
1	B	307:ALA	C	308:ARG	N	3.10
1	D	295:ASN	C	296:ILE	N	3.01

6 Fit of model and data

6.1 Protein, DNA and RNA chains

In the following table, the column labelled ‘#RSRZ > 2’ contains the number (and percentage) of RSRZ outliers, followed by percent RSRZ outliers for the chain as percentile scores relative to all X-ray entries and entries of similar resolution. The OWAB column contains the minimum, median, 95th percentile and maximum values of the occupancy-weighted average B-factor per residue. The column labelled ‘Q < 0.9’ lists the number of (and percentage) of residues with an average occupancy less than 0.9.

Mol	Chain	Analysed	<RSRZ>	#RSRZ>2	OWAB(Å ²)	Q<0.9
1	A	262/285 (91%)	0.08	10 (3%) 40 39	162, 190, 241, 269	0
1	E	259/285 (90%)	0.11	15 (5%) 23 24	155, 185, 236, 251	0
2	B	326/339 (96%)	0.61	41 (12%) 3 4	127, 162, 226, 250	0
2	F	332/339 (97%)	0.55	44 (13%) 3 4	120, 159, 208, 237	0
3	C	365/383 (95%)	0.37	32 (8%) 10 11	112, 152, 257, 274	0
3	D	263/383 (68%)	-0.22	5 (1%) 66 65	187, 227, 271, 278	0
3	G	368/383 (96%)	0.32	33 (8%) 9 11	121, 173, 262, 277	0
3	H	261/383 (68%)	0.17	17 (6%) 18 20	153, 190, 239, 255	0
All	All	2436/2780 (87%)	0.28	197 (8%) 12 13	112, 181, 254, 278	0

All (197) RSRZ outliers are listed below:

Mol	Chain	Res	Type	RSRZ
3	C	166	ALA	9.9
3	C	110	GLU	8.3
1	E	303	CYS	7.3
1	E	302	LEU	6.8
3	D	296	ILE	6.1
3	G	187	VAL	5.9
2	F	155	PHE	5.6
3	C	399	ASP	5.4
3	C	167	VAL	5.3
2	B	198	MET	5.2
1	E	266	CYS	5.1
2	B	199	ALA	4.9
2	B	155	PHE	4.9
3	G	198	GLN	4.7
2	B	235	PHE	4.5
3	C	400	ASN	4.4

Continued on next page...

Continued from previous page...

Mol	Chain	Res	Type	RSRZ
2	F	337	PHE	4.4
2	B	191	ARG	4.2
2	B	138	LEU	4.1
3	D	342	VAL	4.1
2	B	174	VAL	4.1
2	B	163	LEU	4.1
2	B	200	PHE	4.1
3	G	185	LEU	4.0
2	B	164	LEU	3.9
3	H	207	LEU	3.9
2	B	103	PHE	3.9
3	G	186	GLU	3.9
2	B	137	GLU	3.8
2	B	209	LEU	3.8
2	B	203	LEU	3.7
3	G	306	LYS	3.7
2	B	129	LEU	3.7
2	F	296	PHE	3.6
2	F	129	LEU	3.6
3	G	296	ILE	3.6
3	C	198	GLN	3.5
3	H	315	ALA	3.5
1	A	81	ILE	3.5
3	G	142	GLU	3.4
3	G	133	ILE	3.3
3	G	124	ALA	3.3
3	H	373	TYR	3.3
3	C	240	MET	3.3
2	B	184	GLU	3.2
2	B	178	LEU	3.2
2	B	226	PHE	3.2
2	F	187	VAL	3.2
1	E	296	LYS	3.2
3	C	299	PHE	3.2
2	F	163	LEU	3.2
3	C	185	LEU	3.2
2	B	114	LEU	3.2
2	B	159	ILE	3.2
3	G	355	ILE	3.2
2	B	185	LEU	3.2
1	E	268	ARG	3.2
2	F	154	ALA	3.1

Continued on next page...

Continued from previous page...

Mol	Chain	Res	Type	RSRZ
3	G	169	ALA	3.1
2	F	185	LEU	3.1
2	B	124	ILE	3.1
1	A	140	LEU	3.1
3	C	195	LYS	3.0
3	C	196	VAL	3.0
3	H	309	GLU	3.0
1	E	294	VAL	3.0
2	F	272	PHE	3.0
3	G	297	VAL	3.0
2	F	104	PRO	3.0
2	F	200	PHE	2.9
2	F	124	ILE	2.9
2	B	104	PRO	2.9
2	B	166	LEU	2.9
2	F	164	LEU	2.9
2	F	80	PHE	2.9
3	D	343	ILE	2.9
3	G	299	PHE	2.9
2	F	114	LEU	2.9
2	F	103	PHE	2.9
3	D	259	PHE	2.9
2	B	175	PRO	2.9
3	G	100	ARG	2.9
3	C	301	LEU	2.8
3	C	168	VAL	2.8
3	G	363	LEU	2.8
2	B	158	ALA	2.8
1	E	288	PHE	2.8
3	C	274	VAL	2.8
1	E	272	LYS	2.8
3	H	419	SER	2.8
3	G	298	LYS	2.8
2	B	250	PRO	2.7
3	C	259	PHE	2.7
3	G	126	TYR	2.7
2	B	246	PRO	2.7
3	C	210	VAL	2.7
2	F	68	LEU	2.7
3	C	109	ILE	2.7
3	C	250	LEU	2.7
2	B	132	LEU	2.6

Continued on next page...

Continued from previous page...

Mol	Chain	Res	Type	RSRZ
3	C	174	PHE	2.6
3	D	355	ILE	2.6
1	A	82	PHE	2.6
3	C	287	PHE	2.6
2	F	110	ASN	2.6
1	A	137	TRP	2.6
1	E	267	GLY	2.6
2	B	296	PHE	2.6
2	F	161	LEU	2.6
2	F	88	GLN	2.6
2	F	283	ILE	2.6
3	G	121	ILE	2.6
1	E	264	VAL	2.6
2	B	221	ILE	2.6
3	H	389	TYR	2.5
2	B	150	VAL	2.5
3	H	358	LEU	2.5
2	B	113	VAL	2.5
2	F	58	PRO	2.5
3	G	340	LEU	2.5
1	E	152	ILE	2.5
2	B	195	ILE	2.5
2	F	84	LEU	2.5
3	H	390	VAL	2.5
3	H	208	LYS	2.5
2	F	235	PHE	2.5
2	F	259	LEU	2.4
3	G	270	LEU	2.4
2	B	176	VAL	2.4
2	F	166	LEU	2.4
1	A	176	LEU	2.4
2	B	84	LEU	2.4
3	G	391	VAL	2.4
3	H	272	HIS	2.4
2	F	134	LYS	2.4
2	F	334	VAL	2.4
1	E	265	ARG	2.4
3	G	288	PHE	2.4
3	C	112	ARG	2.4
3	C	163	THR	2.4
2	F	61	ILE	2.4
3	H	420	LEU	2.4

Continued on next page...

Continued from previous page...

Mol	Chain	Res	Type	RSRZ
3	G	110	GLU	2.4
2	F	267	ILE	2.3
3	H	392	LYS	2.3
2	F	132	LEU	2.3
3	G	312	ILE	2.3
2	F	57	VAL	2.3
2	B	291	LEU	2.3
3	G	188	GLN	2.3
1	A	107	LEU	2.3
3	C	360	PRO	2.3
3	H	459	PHE	2.3
1	E	249	VAL	2.2
3	G	122	GLU	2.2
2	B	156	ARG	2.2
3	C	363	LEU	2.2
1	E	270	TRP	2.2
2	F	59	LEU	2.2
2	F	351	ARG	2.2
3	C	282	TYR	2.2
3	H	355	ILE	2.2
3	C	164	GLN	2.2
3	C	433	ALA	2.2
2	F	299	LEU	2.2
3	G	331	ILE	2.2
1	E	153	ALA	2.2
2	F	131	GLN	2.2
2	B	145	ILE	2.2
2	F	295	VAL	2.2
3	G	101	GLU	2.2
3	H	246	ARG	2.2
2	B	171	LEU	2.1
2	F	249	LEU	2.1
3	H	363	LEU	2.1
3	C	297	VAL	2.1
3	C	270	LEU	2.1
3	G	343	ILE	2.1
3	G	358	LEU	2.1
3	C	286	LEU	2.1
2	F	135	LEU	2.1
1	A	288	PHE	2.1
3	G	240	MET	2.1
3	C	277	THR	2.1

Continued on next page...

Continued from previous page...

Mol	Chain	Res	Type	RSRZ
2	F	162	LYS	2.1
3	G	287	PHE	2.1
2	B	334	VAL	2.1
2	F	159	ILE	2.1
3	C	288	PHE	2.0
2	F	257	LEU	2.0
1	A	52	PRO	2.0
2	F	246	PRO	2.0
3	H	331	ILE	2.0
3	G	250	LEU	2.0
1	A	80	GLN	2.0
1	A	54	PHE	2.0
2	F	363	ARG	2.0

6.2 Non-standard residues in protein, DNA, RNA chains [i](#)

There are no non-standard protein/DNA/RNA residues in this entry.

6.3 Carbohydrates [i](#)

There are no monosaccharides in this entry.

6.4 Ligands [i](#)

LIGAND-RSR INFOmissingINFO

6.5 Other polymers [i](#)

There are no such residues in this entry.