



# Full wwPDB X-ray Structure Validation Report ⓘ

Jun 19, 2024 – 01:14 PM EDT

PDB ID : 4CYI  
Title : Chaetomium thermophilum Pan3  
Authors : Wolf, J.; Valkov, E.; Allen, M.D.; Meineke, B.; Gordiyenko, Y.; McLaughlin, S.H.; Olsen, T.M.; Robinson, C.V.; Bycroft, M.; Stewart, M.; Passmore, L.A.  
Deposited on : 2014-04-11  
Resolution : 2.42 Å(reported)

This is a Full wwPDB X-ray Structure Validation Report for a publicly released PDB entry.

We welcome your comments at [validation@mail.wwpdb.org](mailto:validation@mail.wwpdb.org)

A user guide is available at

<https://www.wwpdb.org/validation/2017/XrayValidationReportHelp>

with specific help available everywhere you see the ⓘ symbol.

The types of validation reports are described at

<http://www.wwpdb.org/validation/2017/FAQs#types>.

---

The following versions of software and data (see [references ⓘ](#)) were used in the production of this report:

MolProbity : 4.02b-467  
Mogul : 2022.3.0, CSD as543be (2022)  
Xtriage (Phenix) : 1.20.1  
EDS : 2.37.1  
buster-report : 1.1.7 (2018)  
Percentile statistics : 20191225.v01 (using entries in the PDB archive December 25th 2019)  
Refmac : 5.8.0158  
CCP4 : 7.0.044 (Gargrove)  
Ideal geometry (proteins) : Engh & Huber (2001)  
Ideal geometry (DNA, RNA) : Parkinson et al. (1996)  
Validation Pipeline (wwPDB-VP) : 2.37.1

# 1 Overall quality at a glance

The following experimental techniques were used to determine the structure:

*X-RAY DIFFRACTION*

The reported resolution of this entry is 2.42 Å.

Percentile scores (ranging between 0-100) for global validation metrics of the entry are shown in the following graphic. The table shows the number of entries on which the scores are based.

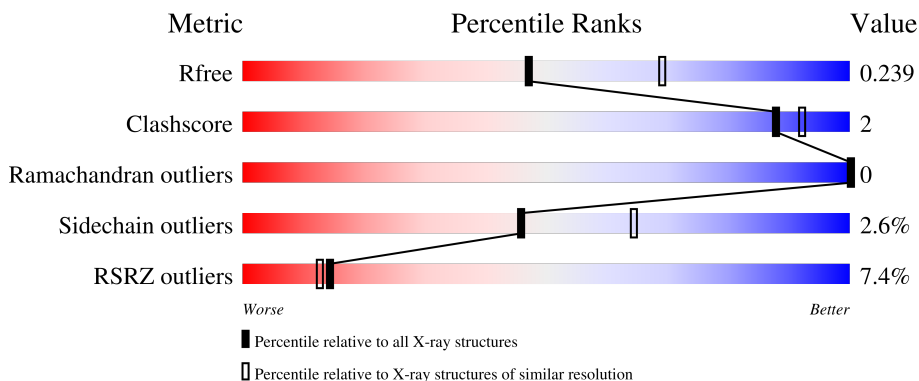



Metric	Whole archive (#Entries)	Similar resolution (#Entries, resolution range(Å))
$R_{free}$	130704	4647 (2.44-2.40)
Clashscore	141614	5161 (2.44-2.40)
Ramachandran outliers	138981	5073 (2.44-2.40)
Sidechain outliers	138945	5074 (2.44-2.40)
RSRZ outliers	127900	4543 (2.44-2.40)

The table below summarises the geometric issues observed across the polymeric chains and their fit to the electron density. The red, orange, yellow and green segments of the lower bar indicate the fraction of residues that contain outliers for  $\geq 3$ , 2, 1 and 0 types of geometric quality criteria respectively. A grey segment represents the fraction of residues that are not modelled. The numeric value for each fraction is indicated below the corresponding segment, with a dot representing fractions  $\leq 5\%$ . The upper red bar (where present) indicates the fraction of residues that have poor fit to the electron density. The numeric value is given above the bar.

Mol	Chain	Length	Quality of chain
1	A	438	 4% 87% 5% • 8%
1	B	438	 6% 84% 8% • 7%
1	C	438	 7% 86% • 9%
1	D	438	 5% 87% 5% 7%
1	E	438	 12% 85% • • 10%

*Continued on next page...*

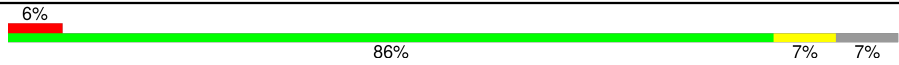
*Continued from previous page...*

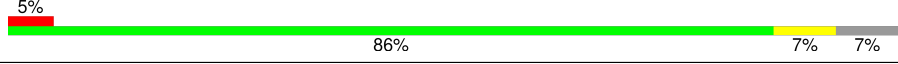
Mol	Chain	Length	Quality of chain
1	F	438	
1	G	438	
1	H	438	

## 2 Entry composition [i](#)

There are 4 unique types of molecules in this entry. The entry contains 53391 atoms, of which 26174 are hydrogens and 0 are deuteriums.

In the tables below, the ZeroOcc column contains the number of atoms modelled with zero occupancy, the AltConf column contains the number of residues with at least one atom in alternate conformation and the Trace column contains the number of residues modelled with at most 2 atoms.

- Molecule 1 is a protein called PAB-DEPENDENT POLY(A)-SPECIFIC RIBONUCLEASE SUBUNIT PAN3-LIKE PROTEIN, PAB-DEPENDENT POLY(A)-SPECIFIC RIBONUCLEASE SUBUNIT PAN3-L PROTEIN.

Mol	Chain	Residues	Atoms							ZeroOcc	AltConf	Trace
			Total	C	H	N	O	S	Se			
1	A	405	6562	2080	3289	581	598	5	9	0	0	0
1	B	406	6565	2082	3290	577	602	5	9	0	0	0
1	C	397	6421	2036	3219	564	588	5	9	0	0	0
1	D	407	6560	2082	3284	575	605	5	9	0	0	0
1	E	394	6386	2024	3202	561	585	5	9	0	0	0
1	F	408	6584	2088	3297	579	606	5	9	0	0	0
1	G	397	6429	2035	3223	568	589	5	9	0	0	0
1	H	407	6559	2083	3282	575	605	5	9	0	0	0

- Molecule 2 is ADENOSINE-5'-TRIPHOSPHATE (three-letter code: ATP) (formula:  $C_{10}H_{16}N_5O_{13}P_3$ ).



Mol	Chain	Residues	Atoms					ZeroOcc	AltConf	
			Total	C	H	N	O			P
2	A	1	Total	C	H	N	O	P	0	0
			42	10	11	5	13	3		
2	B	1	Total	C	H	N	O	P	0	0
			42	10	11	5	13	3		
2	C	1	Total	C	H	N	O	P	0	0
			42	10	11	5	13	3		
2	D	1	Total	C	H	N	O	P	0	0
			42	10	11	5	13	3		
2	E	1	Total	C	H	N	O	P	0	0
			42	10	11	5	13	3		
2	F	1	Total	C	H	N	O	P	0	0
			42	10	11	5	13	3		
2	G	1	Total	C	H	N	O	P	0	0
			42	10	11	5	13	3		
2	H	1	Total	C	H	N	O	P	0	0
			42	10	11	5	13	3		

- Molecule 3 is MAGNESIUM ION (three-letter code: MG) (formula: Mg).

Mol	Chain	Residues	Atoms		ZeroOcc	AltConf
3	A	1	Total	Mg	0	0
			1	1		
3	B	1	Total	Mg	0	0
			1	1		
3	C	1	Total	Mg	0	0
			1	1		
3	D	1	Total	Mg	0	0
			1	1		

*Continued on next page...*

*Continued from previous page...*

Mol	Chain	Residues	Atoms		ZeroOcc	AltConf
3	E	1	Total 1	Mg 1	0	0
3	F	1	Total 1	Mg 1	0	0
3	G	1	Total 1	Mg 1	0	0
3	H	1	Total 1	Mg 1	0	0

- Molecule 4 is water.

Mol	Chain	Residues	Atoms		ZeroOcc	AltConf
4	A	183	Total 183	O 183	0	0
4	B	129	Total 129	O 129	0	0
4	C	110	Total 110	O 110	0	0
4	D	149	Total 149	O 149	0	0
4	E	79	Total 79	O 79	0	0
4	F	92	Total 92	O 92	0	0
4	G	112	Total 112	O 112	0	0
4	H	127	Total 127	O 127	0	0

### 3 Residue-property plots [i](#)

These plots are drawn for all protein, RNA, DNA and oligosaccharide chains in the entry. The first graphic for a chain summarises the proportions of the various outlier classes displayed in the second graphic. The second graphic shows the sequence view annotated by issues in geometry and electron density. Residues are color-coded according to the number of geometric quality criteria for which they contain at least one outlier: green = 0, yellow = 1, orange = 2 and red = 3 or more. A red dot above a residue indicates a poor fit to the electron density ( $RSRZ > 2$ ). Stretches of 2 or more consecutive residues without any outlier are shown as a green connector. Residues present in the sample, but not in the model, are shown in grey.

- Molecule 1: PAB-DEPENDENT POLY(A)-SPECIFIC RIBONUCLEASE SUBUNIT PAN3-LIKE PROTEIN, PAB-DEPENDENT POLY(A)-SPECIFIC RIBONUCLEASE SUBUNIT PAN3-L PROTEIN

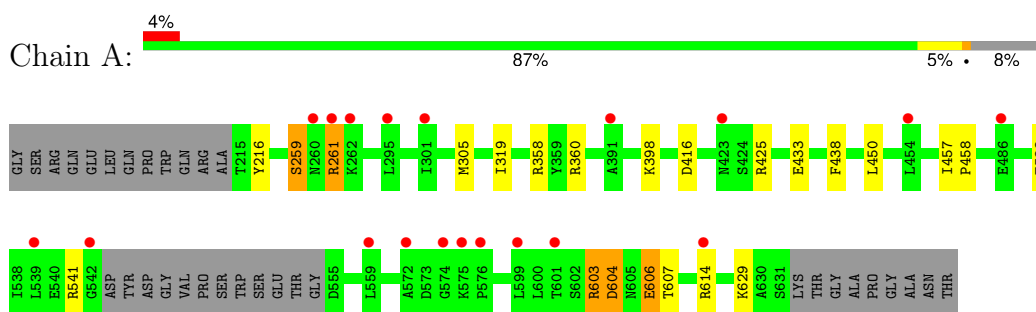

- Molecule 1: PAB-DEPENDENT POLY(A)-SPECIFIC RIBONUCLEASE SUBUNIT PAN3-LIKE PROTEIN, PAB-DEPENDENT POLY(A)-SPECIFIC RIBONUCLEASE SUBUNIT PAN3-L PROTEIN

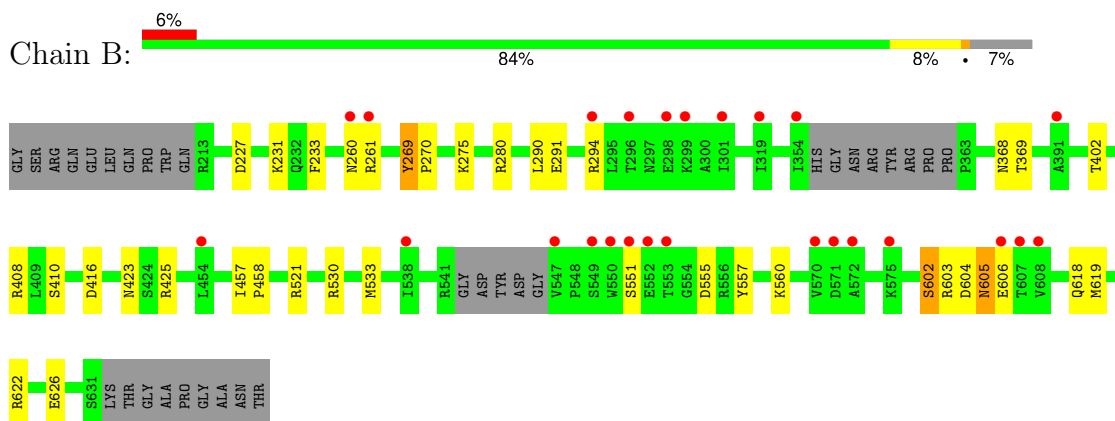

- Molecule 1: PAB-DEPENDENT POLY(A)-SPECIFIC RIBONUCLEASE SUBUNIT PAN3-LIKE PROTEIN, PAB-DEPENDENT POLY(A)-SPECIFIC RIBONUCLEASE SUBUNIT PAN3-L PROTEIN

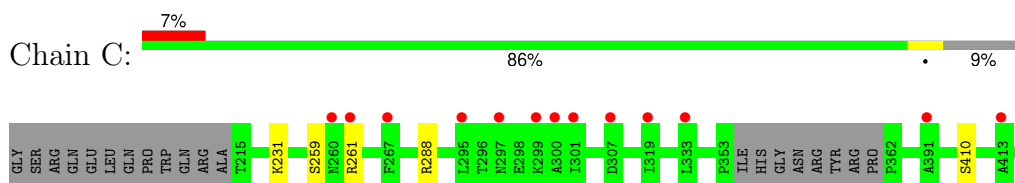

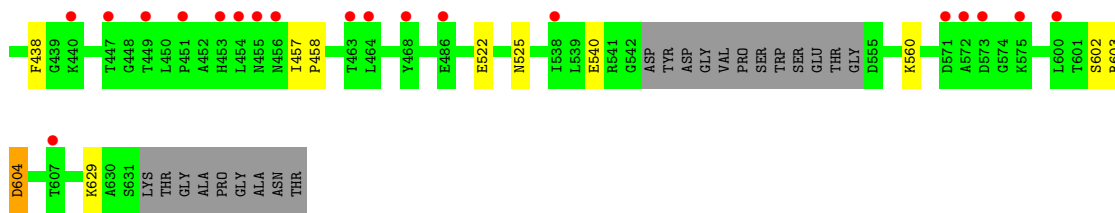

- Molecule 1: PAB-DEPENDENT POLY(A)-SPECIFIC RIBONUCLEASE SUBUNIT PAN3-LIKE PROTEIN, PAB-DEPENDENT POLY(A)-SPECIFIC RIBONUCLEASE SUBUNIT PAN3-L PROTEIN

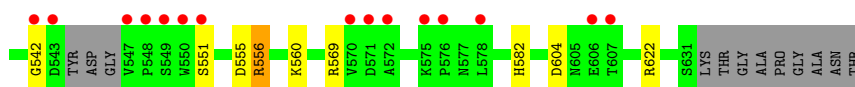
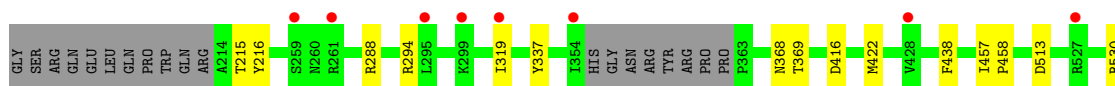
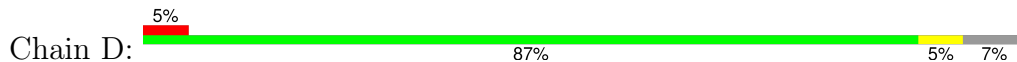

- Molecule 1: PAB-DEPENDENT POLY(A)-SPECIFIC RIBONUCLEASE SUBUNIT PAN3-LIKE PROTEIN, PAB-DEPENDENT POLY(A)-SPECIFIC RIBONUCLEASE SUBUNIT PAN3-L PROTEIN

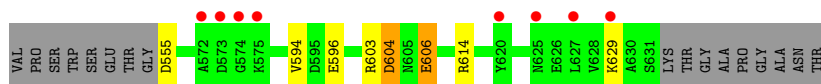
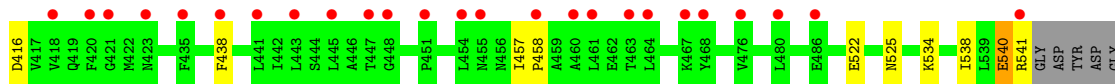
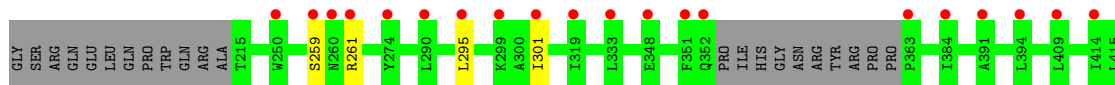
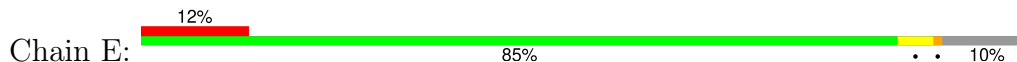

- Molecule 1: PAB-DEPENDENT POLY(A)-SPECIFIC RIBONUCLEASE SUBUNIT PAN3-LIKE PROTEIN, PAB-DEPENDENT POLY(A)-SPECIFIC RIBONUCLEASE SUBUNIT PAN3-L PROTEIN

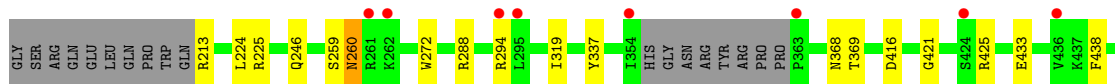
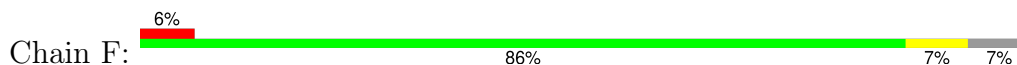



- Molecule 1: PAB-DEPENDENT POLY(A)-SPECIFIC RIBONUCLEASE SUBUNIT PAN3-LIKE PROTEIN, PAB-DEPENDENT POLY(A)-SPECIFIC RIBONUCLEASE SUBUNIT PAN3-L PROTEIN

Chain G: 

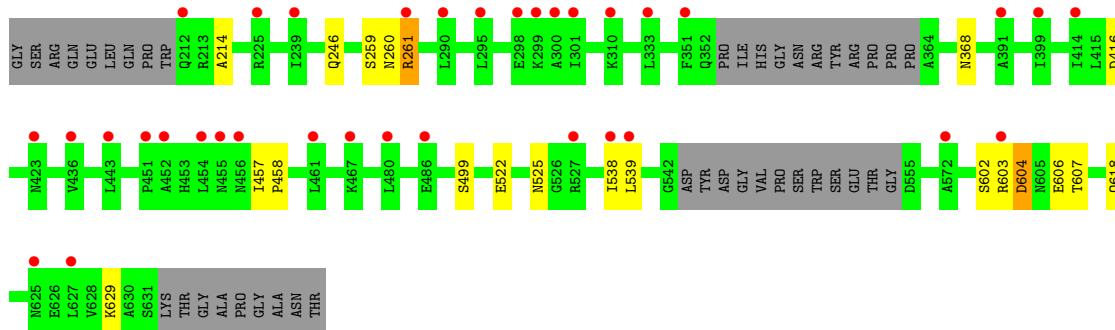

- Molecule 1: PAB-DEPENDENT POLY(A)-SPECIFIC RIBONUCLEASE SUBUNIT PAN3-LIKE PROTEIN, PAB-DEPENDENT POLY(A)-SPECIFIC RIBONUCLEASE SUBUNIT PAN3-L PROTEIN

Chain H: 

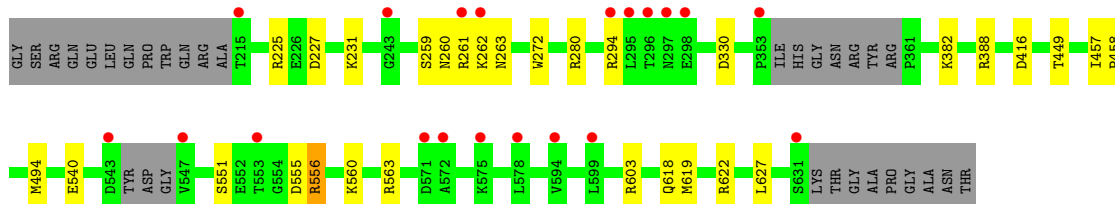

## 4 Data and refinement statistics i

Property	Value	Source
Space group	P 1	Depositor
Cell constants a, b, c, $\alpha$ , $\beta$ , $\gamma$	51.52Å 146.04Å 149.93Å 89.81° 81.13° 82.77°	Depositor
Resolution (Å)	52.21 – 2.42 52.21 – 2.42	Depositor EDS
% Data completeness (in resolution range)	98.4 (52.21-2.42) 97.6 (52.21-2.42)	Depositor EDS
$R_{merge}$	0.04	Depositor
$R_{sym}$	(Not available)	Depositor
$\langle I/\sigma(I) \rangle$ <sup>1</sup>	2.78 (at 2.42Å)	Xtrriage
Refinement program	PHENIX (PHENIX.REFINE)	Depositor
R, $R_{free}$	0.190 , 0.234 0.195 , 0.239	Depositor DCC
$R_{free}$ test set	7997 reflections (5.02%)	wwPDB-VP
Wilson B-factor (Å <sup>2</sup> )	48.9	Xtrriage
Anisotropy	0.894	Xtrriage
Bulk solvent $k_{sol}$ (e/Å <sup>3</sup> ), $B_{sol}$ (Å <sup>2</sup> )	0.38 , 63.3	EDS
L-test for twinning <sup>2</sup>	$\langle  L  \rangle = 0.48$ , $\langle L^2 \rangle = 0.31$	Xtrriage
Estimated twinning fraction	0.014 for -h,-k,-h+l	Xtrriage
$F_o, F_c$ correlation	0.95	EDS
Total number of atoms	53391	wwPDB-VP
Average B, all atoms (Å <sup>2</sup> )	77.0	wwPDB-VP

Xtrriage's analysis on translational NCS is as follows: *The largest off-origin peak in the Patterson function is 3.47% of the height of the origin peak. No significant pseudotranslation is detected.*

<sup>1</sup>Intensities estimated from amplitudes.

<sup>2</sup>Theoretical values of  $\langle |L| \rangle$ ,  $\langle L^2 \rangle$  for acentric reflections are 0.5, 0.333 respectively for untwinned datasets, and 0.375, 0.2 for perfectly twinned datasets.

## 5 Model quality [i](#)

### 5.1 Standard geometry [i](#)

Bond lengths and bond angles in the following residue types are not validated in this section: ATP, MG

The Z score for a bond length (or angle) is the number of standard deviations the observed value is removed from the expected value. A bond length (or angle) with  $|Z| > 5$  is considered an outlier worth inspection. RMSZ is the root-mean-square of all Z scores of the bond lengths (or angles).

Mol	Chain	Bond lengths		Bond angles	
		RMSZ	# Z  >5	RMSZ	# Z  >5
1	A	0.27	0/3334	0.46	0/4495
1	B	0.26	0/3334	0.45	0/4494
1	C	0.25	0/3259	0.43	0/4391
1	D	0.26	0/3335	0.44	0/4496
1	E	0.25	0/3239	0.43	0/4362
1	F	0.25	0/3346	0.44	0/4510
1	G	0.25	0/3260	0.44	0/4389
1	H	0.26	0/3338	0.46	0/4502
All	All	0.26	0/26445	0.44	0/35639

There are no bond length outliers.

There are no bond angle outliers.

There are no chirality outliers.

There are no planarity outliers.

### 5.2 Too-close contacts [i](#)

In the following table, the Non-H and H(model) columns list the number of non-hydrogen atoms and hydrogen atoms in the chain respectively. The H(added) column lists the number of hydrogen atoms added and optimized by MolProbity. The Clashes column lists the number of clashes within the asymmetric unit, whereas Symm-Clashes lists symmetry-related clashes.

Mol	Chain	Non-H	H(model)	H(added)	Clashes	Symm-Clashes
1	A	3273	3289	3275	17	0
1	B	3275	3290	3277	20	0
1	C	3202	3219	3206	10	0
1	D	3276	3284	3271	13	0
1	E	3184	3202	3189	13	0

*Continued on next page...*

Continued from previous page...

Mol	Chain	Non-H	H(model)	H(added)	Clashes	Symm-Clashes
1	F	3287	3297	3284	15	0
1	G	3206	3223	3210	9	0
1	H	3277	3282	3269	14	0
2	A	31	11	12	1	0
2	B	31	11	12	0	0
2	C	31	11	12	1	0
2	D	31	11	12	2	0
2	E	31	11	12	0	0
2	F	31	11	12	0	0
2	G	31	11	12	0	0
2	H	31	11	12	0	0
3	A	1	0	0	0	0
3	B	1	0	0	0	0
3	C	1	0	0	0	0
3	D	1	0	0	0	0
3	E	1	0	0	0	0
3	F	1	0	0	0	0
3	G	1	0	0	0	0
3	H	1	0	0	0	0
4	A	183	0	0	2	0
4	B	129	0	0	3	0
4	C	110	0	0	6	0
4	D	149	0	0	2	0
4	E	79	0	0	2	0
4	F	92	0	0	1	0
4	G	112	0	0	1	0
4	H	127	0	0	1	0
All	All	27217	26174	26077	106	0

The all-atom clashscore is defined as the number of clashes found per 1000 atoms (including hydrogen atoms). The all-atom clashscore for this structure is 2.

All (106) close contacts within the same asymmetric unit are listed below, sorted by their clash magnitude.

Atom-1	Atom-2	Interatomic distance (Å)	Clash overlap (Å)
1:B:227:ASP:OD2	1:B:231:LYS:NZ	2.20	0.75
1:F:260:ASN:O	1:F:260:ASN:ND2	2.20	0.75
1:F:225:ARG:NH1	4:F:2005:HOH:O	2.26	0.69
1:A:398:LYS:NZ	2:A:900:ATP:O1G	2.27	0.67
4:C:2072:HOH:O	1:D:513:ASP:OD1	2.12	0.66
1:B:604:ASP:O	1:B:605:ASN:ND2	2.28	0.65

Continued on next page...

*Continued from previous page...*

Atom-1	Atom-2	Interatomic distance (Å)	Clash overlap (Å)
1:D:551:SER:O	1:D:560:LYS:NZ	2.30	0.65
1:B:555:ASP:OD2	1:B:622:ARG:NH1	2.30	0.64
1:B:280:ARG:NH1	4:B:2020:HOH:O	2.30	0.64
1:C:560:LYS:NZ	4:C:2097:HOH:O	2.31	0.64
1:A:259:SER:OG	1:D:294:ARG:NH1	2.31	0.63
1:B:260:ASN:N	1:E:606:GLU:O	2.30	0.63
1:C:603:ARG:NH1	1:D:542:GLY:O	2.32	0.63
1:A:606:GLU:O	1:F:260:ASN:N	2.32	0.62
1:F:555:ASP:OD2	1:F:622:ARG:NH1	2.32	0.62
1:B:260:ASN:O	1:B:260:ASN:ND2	2.33	0.62
1:F:551:SER:O	1:F:560:LYS:NZ	2.34	0.61
1:A:358:ARG:NH2	4:A:2085:HOH:O	2.33	0.61
1:C:410:SER:O	4:C:2037:HOH:O	2.17	0.59
1:H:555:ASP:OD2	1:H:622:ARG:NH1	2.36	0.57
1:B:557:TYR:OH	1:B:602:SER:OG	2.22	0.57
1:A:614:ARG:NH1	4:A:2176:HOH:O	2.32	0.57
1:A:604:ASP:N	1:A:604:ASP:OD1	2.35	0.57
1:G:499:SER:O	1:H:382:LYS:NZ	2.38	0.57
1:E:522:GLU:OE1	1:E:525:ASN:ND2	2.38	0.56
1:B:551:SER:O	1:B:560:LYS:NZ	2.38	0.55
1:E:534:LYS:O	1:E:538:ILE:HD12	2.07	0.55
1:A:537:THR:O	1:A:541:ARG:NH1	2.40	0.54
1:A:603:ARG:NE	1:A:603:ARG:HA	2.24	0.53
1:A:522:GLU:OE1	1:A:525:ASN:ND2	2.40	0.52
1:D:555:ASP:OD2	1:D:622:ARG:NH1	2.43	0.52
1:E:614:ARG:NH1	4:E:2077:HOH:O	2.38	0.52
1:B:275:LYS:NZ	4:B:2017:HOH:O	2.43	0.51
1:A:603:ARG:HA	1:A:603:ARG:HE	1.76	0.51
1:H:540:GLU:OE2	1:H:563:ARG:NH2	2.44	0.51
1:F:260:ASN:OD1	1:F:272:TRP:NE1	2.44	0.50
1:G:246:GLN:NE2	4:G:2017:HOH:O	2.43	0.50
1:G:538:ILE:HD12	1:G:539:LEU:HG	1.93	0.50
1:H:227:ASP:OD2	1:H:231:LYS:NZ	2.40	0.49
1:H:261:ARG:O	1:H:263:ASN:N	2.44	0.49
1:C:288:ARG:NH1	4:C:2029:HOH:O	2.45	0.49
1:F:425:ARG:NH1	1:F:433:GLU:OE2	2.46	0.49
1:H:555:ASP:HA	1:H:619:MSE:HE2	1.94	0.49
1:A:305:MSE:HE1	1:A:319:ILE:HG12	1.95	0.48
1:A:425:ARG:NH1	1:A:433:GLU:OE2	2.46	0.48
1:F:555:ASP:HA	1:F:619:MSE:HE2	1.95	0.48
1:G:602:SER:HB2	1:G:607:THR:HG23	1.95	0.48

*Continued on next page...*

*Continued from previous page...*

Atom-1	Atom-2	Interatomic distance (Å)	Clash overlap (Å)
1:D:530:ARG:NE	4:D:2135:HOH:O	2.41	0.48
1:D:319:ILE:HG22	1:D:337:TYR:CE2	2.49	0.47
1:D:288:ARG:HH22	2:D:900:ATP:PA	2.37	0.47
1:F:524:GLU:OE1	1:F:527:ARG:NH1	2.42	0.47
1:G:604:ASP:OD1	1:G:604:ASP:N	2.36	0.47
1:C:425:ARG:NH1	1:C:433:GLU:OE2	2.47	0.47
1:D:368:ASN:OD1	1:D:369:THR:N	2.48	0.46
1:E:457:ILE:HB	1:E:458:PRO:HD3	1.97	0.46
1:H:260:ASN:HB2	1:H:272:TRP:HE1	1.81	0.46
1:G:260:ASN:O	1:G:261:ARG:NH2	2.48	0.46
1:E:555:ASP:N	4:E:2066:HOH:O	2.48	0.46
1:F:421:GLY:O	1:H:618:GLN:NE2	2.47	0.46
1:H:457:ILE:HB	1:H:458:PRO:HD3	1.97	0.46
2:D:900:ATP:O1B	4:D:2061:HOH:O	2.21	0.46
1:D:556:ARG:N	1:D:556:ARG:HD3	2.31	0.46
2:C:900:ATP:O1A	4:C:2029:HOH:O	2.20	0.45
1:E:604:ASP:OD1	1:E:604:ASP:N	2.37	0.45
1:B:269:TYR:HB2	1:B:290:LEU:HD22	1.99	0.45
1:G:214:ALA:HB2	1:G:368:ASN:HB3	1.97	0.45
1:G:522:GLU:OE1	1:G:525:ASN:ND2	2.49	0.45
1:F:457:ILE:HB	1:F:458:PRO:HD3	1.99	0.45
1:G:457:ILE:HB	1:G:458:PRO:HD3	1.99	0.45
1:C:457:ILE:HB	1:C:458:PRO:HD3	1.98	0.45
1:A:261:ARG:HA	1:A:261:ARG:HE	1.82	0.45
1:B:423:ASN:OD1	1:B:425:ARG:N	2.50	0.45
1:C:231:LYS:NZ	4:C:2009:HOH:O	2.43	0.45
1:H:382:LYS:HD2	1:H:494:MSE:SE	2.67	0.44
1:B:261:ARG:HG3	1:E:606:GLU:HB2	2.00	0.44
1:B:530:ARG:HA	1:B:533:MSE:HE3	2.00	0.44
1:C:602:SER:OG	1:C:604:ASP:O	2.32	0.44
1:D:457:ILE:HB	1:D:458:PRO:HD3	1.98	0.44
1:D:569:ARG:HD2	1:D:582:HIS:CD2	2.53	0.44
1:E:301:ILE:H	1:E:301:ILE:HD12	1.82	0.44
1:H:551:SER:O	1:H:560:LYS:NZ	2.48	0.44
1:C:604:ASP:N	1:C:604:ASP:OD1	2.49	0.44
1:E:295:LEU:HD11	1:E:301:ILE:HD11	1.99	0.44
1:B:618:GLN:OE1	4:B:2126:HOH:O	2.21	0.44
1:B:457:ILE:HB	1:B:458:PRO:HD3	1.99	0.44
1:F:319:ILE:HG22	1:F:337:TYR:CE2	2.52	0.43
1:A:457:ILE:HB	1:A:458:PRO:HD3	2.00	0.43
1:B:368:ASN:OD1	1:B:369:THR:N	2.52	0.43

*Continued on next page...*

Continued from previous page...

Atom-1	Atom-2	Interatomic distance (Å)	Clash overlap (Å)
1:H:261:ARG:HD3	1:H:263:ASN:HB2	2.01	0.43
1:B:270:PRO:HG2	1:B:291:GLU:HB3	2.00	0.42
1:E:540:GLU:N	1:E:540:GLU:OE1	2.51	0.42
1:E:295:LEU:HD21	1:E:301:ILE:HD11	2.01	0.42
1:A:305:MSE:HE2	1:A:305:MSE:HA	2.01	0.42
1:C:522:GLU:OE1	1:C:525:ASN:ND2	2.53	0.42
1:H:556:ARG:N	1:H:556:ARG:HD3	2.34	0.42
1:F:450:LEU:HG	1:F:451:PRO:HD2	2.02	0.42
1:B:402:THR:HG21	1:B:408:ARG:HD3	2.01	0.42
1:F:556:ARG:N	1:F:556:ARG:HD3	2.35	0.42
1:F:368:ASN:OD1	1:F:369:THR:N	2.53	0.41
1:A:606:GLU:OE1	1:A:607:THR:N	2.53	0.41
1:B:622:ARG:O	1:B:626:GLU:HG3	2.21	0.41
1:H:330:ASP:O	4:H:2039:HOH:O	2.22	0.41
1:B:555:ASP:HA	1:B:619:MSE:HE2	2.02	0.40
1:A:606:GLU:OE1	1:A:606:GLU:N	2.54	0.40
1:D:215:THR:HG22	1:D:216:TYR:N	2.36	0.40
1:E:594:VAL:HG12	1:E:596:GLU:H	1.86	0.40

There are no symmetry-related clashes.

## 5.3 Torsion angles

### 5.3.1 Protein backbone

In the following table, the Percentiles column shows the percent Ramachandran outliers of the chain as a percentile score with respect to all X-ray entries followed by that with respect to entries of similar resolution.

The Analysed column shows the number of residues for which the backbone conformation was analysed, and the total number of residues.

Mol	Chain	Analysed	Favoured	Allowed	Outliers	Percentiles	
1	A	401/438 (92%)	396 (99%)	5 (1%)	0	100	100
1	B	400/438 (91%)	397 (99%)	3 (1%)	0	100	100
1	C	391/438 (89%)	389 (100%)	2 (0%)	0	100	100
1	D	401/438 (92%)	397 (99%)	4 (1%)	0	100	100
1	E	388/438 (89%)	386 (100%)	2 (0%)	0	100	100
1	F	402/438 (92%)	398 (99%)	4 (1%)	0	100	100

Continued on next page...

*Continued from previous page...*

Mol	Chain	Analysed	Favoured	Allowed	Outliers	Percentiles	
1	G	391/438 (89%)	386 (99%)	5 (1%)	0	100	100
1	H	401/438 (92%)	398 (99%)	3 (1%)	0	100	100
All	All	3175/3504 (91%)	3147 (99%)	28 (1%)	0	100	100

There are no Ramachandran outliers to report.

### 5.3.2 Protein sidechains [i](#)

In the following table, the Percentiles column shows the percent sidechain outliers of the chain as a percentile score with respect to all X-ray entries followed by that with respect to entries of similar resolution.

The Analysed column shows the number of residues for which the sidechain conformation was analysed, and the total number of residues.

Mol	Chain	Analysed	Rotameric	Outliers	Percentiles	
1	A	360/376 (96%)	349 (97%)	11 (3%)	40	58
1	B	361/376 (96%)	351 (97%)	10 (3%)	43	62
1	C	353/376 (94%)	346 (98%)	7 (2%)	55	72
1	D	361/376 (96%)	356 (99%)	5 (1%)	67	81
1	E	351/376 (93%)	341 (97%)	10 (3%)	43	62
1	F	362/376 (96%)	351 (97%)	11 (3%)	41	59
1	G	352/376 (94%)	344 (98%)	8 (2%)	50	68
1	H	362/376 (96%)	351 (97%)	11 (3%)	41	59
All	All	2862/3008 (95%)	2789 (97%)	73 (3%)	46	64

All (73) residues with a non-rotameric sidechain are listed below:

Mol	Chain	Res	Type
1	A	216	TYR
1	A	259	SER
1	A	261	ARG
1	A	360	ARG
1	A	416	ASP
1	A	438	PHE
1	A	450	LEU
1	A	603	ARG
1	A	604	ASP

*Continued on next page...*



*Continued from previous page...*

<b>Mol</b>	<b>Chain</b>	<b>Res</b>	<b>Type</b>
1	A	606	GLU
1	A	629	LYS
1	B	233	PHE
1	B	269	TYR
1	B	294	ARG
1	B	410	SER
1	B	416	ASP
1	B	521	ARG
1	B	602	SER
1	B	603	ARG
1	B	605	ASN
1	B	606	GLU
1	C	259	SER
1	C	261	ARG
1	C	416	ASP
1	C	438	PHE
1	C	540	GLU
1	C	604	ASP
1	C	629	LYS
1	D	416	ASP
1	D	422	MSE
1	D	438	PHE
1	D	556	ARG
1	D	604	ASP
1	E	259	SER
1	E	261	ARG
1	E	416	ASP
1	E	438	PHE
1	E	540	GLU
1	E	541	ARG
1	E	603	ARG
1	E	604	ASP
1	E	606	GLU
1	E	629	LYS
1	F	213	ARG
1	F	224	LEU
1	F	246	GLN
1	F	259	SER
1	F	260	ASN
1	F	288	ARG
1	F	294	ARG
1	F	416	ASP

*Continued on next page...*

*Continued from previous page...*

Mol	Chain	Res	Type
1	F	438	PHE
1	F	556	ARG
1	F	606	GLU
1	G	259	SER
1	G	261	ARG
1	G	416	ASP
1	G	603	ARG
1	G	604	ASP
1	G	606	GLU
1	G	618	GLN
1	G	629	LYS
1	H	225	ARG
1	H	259	SER
1	H	262	LYS
1	H	280	ARG
1	H	294	ARG
1	H	388	ARG
1	H	416	ASP
1	H	449	THR
1	H	556	ARG
1	H	603	ARG
1	H	627	LEU

Sometimes sidechains can be flipped to improve hydrogen bonding and reduce clashes. All (10) such sidechains are listed below:

Mol	Chain	Res	Type
1	A	597	ASN
1	B	229	GLN
1	D	229	GLN
1	E	568	HIS
1	E	605	ASN
1	F	237	GLN
1	F	246	GLN
1	F	284	HIS
1	F	605	ASN
1	G	260	ASN

### 5.3.3 RNA [i](#)

There are no RNA molecules in this entry.

## 5.4 Non-standard residues in protein, DNA, RNA chains [i](#)

There are no non-standard protein/DNA/RNA residues in this entry.

## 5.5 Carbohydrates [i](#)

There are no monosaccharides in this entry.

## 5.6 Ligand geometry [i](#)

Of 16 ligands modelled in this entry, 8 are monoatomic - leaving 8 for Mogul analysis.

In the following table, the Counts columns list the number of bonds (or angles) for which Mogul statistics could be retrieved, the number of bonds (or angles) that are observed in the model and the number of bonds (or angles) that are defined in the Chemical Component Dictionary. The Link column lists molecule types, if any, to which the group is linked. The Z score for a bond length (or angle) is the number of standard deviations the observed value is removed from the expected value. A bond length (or angle) with  $|Z| > 2$  is considered an outlier worth inspection. RMSZ is the root-mean-square of all Z scores of the bond lengths (or angles).

Mol	Type	Chain	Res	Link	Bond lengths			Bond angles		
					Counts	RMSZ	# Z  > 2	Counts	RMSZ	# Z  > 2
2	ATP	G	900	3	28,33,33	0.96	0	34,52,52	1.29	4 (11%)
2	ATP	C	900	3	28,33,33	0.89	1 (3%)	34,52,52	1.25	2 (5%)
2	ATP	D	900	3	28,33,33	1.00	3 (10%)	34,52,52	1.38	3 (8%)
2	ATP	H	900	3	28,33,33	1.02	2 (7%)	34,52,52	1.39	4 (11%)
2	ATP	A	900	3	28,33,33	0.96	1 (3%)	34,52,52	1.29	3 (8%)
2	ATP	F	900	3	28,33,33	0.97	2 (7%)	34,52,52	1.39	3 (8%)
2	ATP	B	900	3	28,33,33	0.95	1 (3%)	34,52,52	1.34	4 (11%)
2	ATP	E	900	3	28,33,33	1.04	2 (7%)	34,52,52	1.19	3 (8%)

In the following table, the Chirals column lists the number of chiral outliers, the number of chiral centers analysed, the number of these observed in the model and the number defined in the Chemical Component Dictionary. Similar counts are reported in the Torsion and Rings columns. '-' means no outliers of that kind were identified.

Mol	Type	Chain	Res	Link	Chirals	Torsions	Rings
2	ATP	G	900	3	-	3/18/38/38	0/3/3/3
2	ATP	C	900	3	-	0/18/38/38	0/3/3/3
2	ATP	D	900	3	-	2/18/38/38	0/3/3/3
2	ATP	H	900	3	-	4/18/38/38	0/3/3/3

*Continued on next page...*

*Continued from previous page...*

Mol	Type	Chain	Res	Link	Chirals	Torsions	Rings
2	ATP	A	900	3	-	9/18/38/38	0/3/3/3
2	ATP	F	900	3	-	3/18/38/38	0/3/3/3
2	ATP	B	900	3	-	2/18/38/38	0/3/3/3
2	ATP	E	900	3	-	3/18/38/38	0/3/3/3

All (12) bond length outliers are listed below:

Mol	Chain	Res	Type	Atoms	Z	Observed(Å)	Ideal(Å)
2	H	900	ATP	PB-O3A	2.43	1.62	1.59
2	E	900	ATP	PA-O3A	2.40	1.62	1.59
2	A	900	ATP	PA-O3A	2.24	1.61	1.59
2	B	900	ATP	PB-O3B	2.23	1.61	1.59
2	F	900	ATP	PB-O3A	2.18	1.61	1.59
2	H	900	ATP	PA-O3A	2.16	1.61	1.59
2	D	900	ATP	PB-O3B	2.09	1.61	1.59
2	D	900	ATP	PA-O3A	2.06	1.61	1.59
2	F	900	ATP	PB-O3B	2.06	1.61	1.59
2	D	900	ATP	PB-O3A	2.05	1.61	1.59
2	C	900	ATP	PA-O3A	2.03	1.61	1.59
2	E	900	ATP	PB-O3A	2.02	1.61	1.59

All (26) bond angle outliers are listed below:

Mol	Chain	Res	Type	Atoms	Z	Observed(°)	Ideal(°)
2	A	900	ATP	N3-C2-N1	-4.73	122.25	128.67
2	F	900	ATP	N3-C2-N1	-4.51	122.55	128.67
2	H	900	ATP	N3-C2-N1	-4.39	122.71	128.67
2	G	900	ATP	N3-C2-N1	-4.33	122.79	128.67
2	C	900	ATP	N3-C2-N1	-4.32	122.81	128.67
2	B	900	ATP	N3-C2-N1	-4.25	122.91	128.67
2	D	900	ATP	N3-C2-N1	-4.10	123.11	128.67
2	E	900	ATP	N3-C2-N1	-4.09	123.12	128.67
2	D	900	ATP	O4'-C1'-N9	3.12	112.89	108.75
2	H	900	ATP	O4'-C1'-N9	2.79	112.44	108.75
2	H	900	ATP	C1'-N9-C4	-2.61	122.06	126.64
2	F	900	ATP	C1'-N9-C4	-2.60	122.07	126.64
2	F	900	ATP	O4'-C1'-N9	2.59	112.18	108.75
2	B	900	ATP	O4'-C1'-N9	2.58	112.17	108.75
2	G	900	ATP	C4-C5-N7	-2.44	106.76	109.34
2	E	900	ATP	C4-C5-N7	-2.40	106.80	109.34
2	D	900	ATP	C4-C5-N7	-2.38	106.82	109.34

*Continued on next page...*

Continued from previous page...

Mol	Chain	Res	Type	Atoms	Z	Observed(°)	Ideal(°)
2	A	900	ATP	O3G-PG-O2G	2.26	116.27	107.80
2	B	900	ATP	O3A-PB-O1B	-2.21	104.05	110.70
2	H	900	ATP	C4-C5-N7	-2.12	107.10	109.34
2	A	900	ATP	O4'-C1'-N9	2.12	111.55	108.75
2	G	900	ATP	O3G-PG-O2G	2.10	115.69	107.80
2	C	900	ATP	C1'-N9-C4	-2.07	123.01	126.64
2	G	900	ATP	O4'-C1'-N9	2.05	111.47	108.75
2	B	900	ATP	C1'-N9-C4	-2.02	123.09	126.64
2	E	900	ATP	O3G-PG-O2G	2.00	115.31	107.80

There are no chirality outliers.

All (26) torsion outliers are listed below:

Mol	Chain	Res	Type	Atoms
2	A	900	ATP	C5'-O5'-PA-O1A
2	A	900	ATP	C5'-O5'-PA-O3A
2	G	900	ATP	PB-O3A-PA-O5'
2	E	900	ATP	O4'-C4'-C5'-O5'
2	E	900	ATP	C3'-C4'-C5'-O5'
2	G	900	ATP	O4'-C4'-C5'-O5'
2	G	900	ATP	C3'-C4'-C5'-O5'
2	H	900	ATP	PG-O3B-PB-O1B
2	E	900	ATP	PB-O3A-PA-O5'
2	A	900	ATP	PB-O3B-PG-O1G
2	A	900	ATP	PA-O3A-PB-O1B
2	A	900	ATP	PB-O3A-PA-O2A
2	B	900	ATP	PG-O3B-PB-O2B
2	D	900	ATP	PG-O3B-PB-O2B
2	F	900	ATP	PG-O3B-PB-O2B
2	H	900	ATP	PG-O3B-PB-O2B
2	H	900	ATP	PB-O3B-PG-O1G
2	A	900	ATP	PB-O3B-PG-O2G
2	A	900	ATP	PB-O3B-PG-O3G
2	A	900	ATP	PB-O3A-PA-O1A
2	B	900	ATP	PG-O3B-PB-O1B
2	F	900	ATP	PG-O3B-PB-O1B
2	F	900	ATP	PB-O3A-PA-O2A
2	A	900	ATP	PA-O3A-PB-O2B
2	D	900	ATP	PB-O3A-PA-O2A
2	H	900	ATP	PB-O3A-PA-O2A

There are no ring outliers.

3 monomers are involved in 4 short contacts:

Mol	Chain	Res	Type	Clashes	Symm-Clashes
2	C	900	ATP	1	0
2	D	900	ATP	2	0
2	A	900	ATP	1	0

The following is a two-dimensional graphical depiction of Mogul quality analysis of bond lengths, bond angles, torsion angles, and ring geometry for all instances of the Ligand of Interest. In addition, ligands with molecular weight > 250 and outliers as shown on the validation Tables will also be included. For torsion angles, if less than 5% of the Mogul distribution of torsion angles is within 10 degrees of the torsion angle in question, then that torsion angle is considered an outlier. Any bond that is central to one or more torsion angles identified as an outlier by Mogul will be highlighted in the graph. For rings, the root-mean-square deviation (RMSD) between the ring in question and similar rings identified by Mogul is calculated over all ring torsion angles. If the average RMSD is greater than 60 degrees and the minimal RMSD between the ring in question and any Mogul-identified rings is also greater than 60 degrees, then that ring is considered an outlier. The outliers are highlighted in purple. The color gray indicates Mogul did not find sufficient equivalents in the CSD to analyse the geometry.

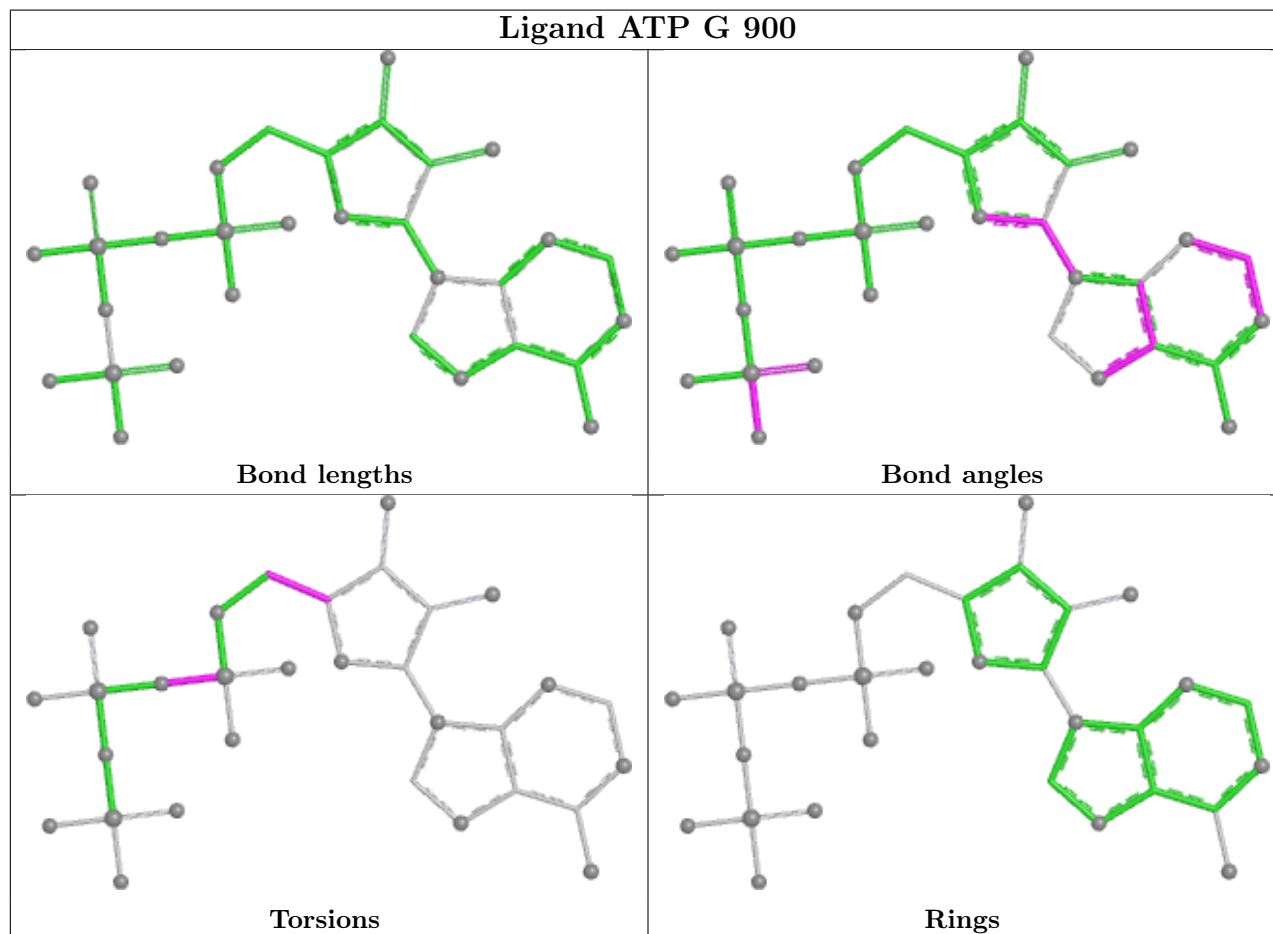

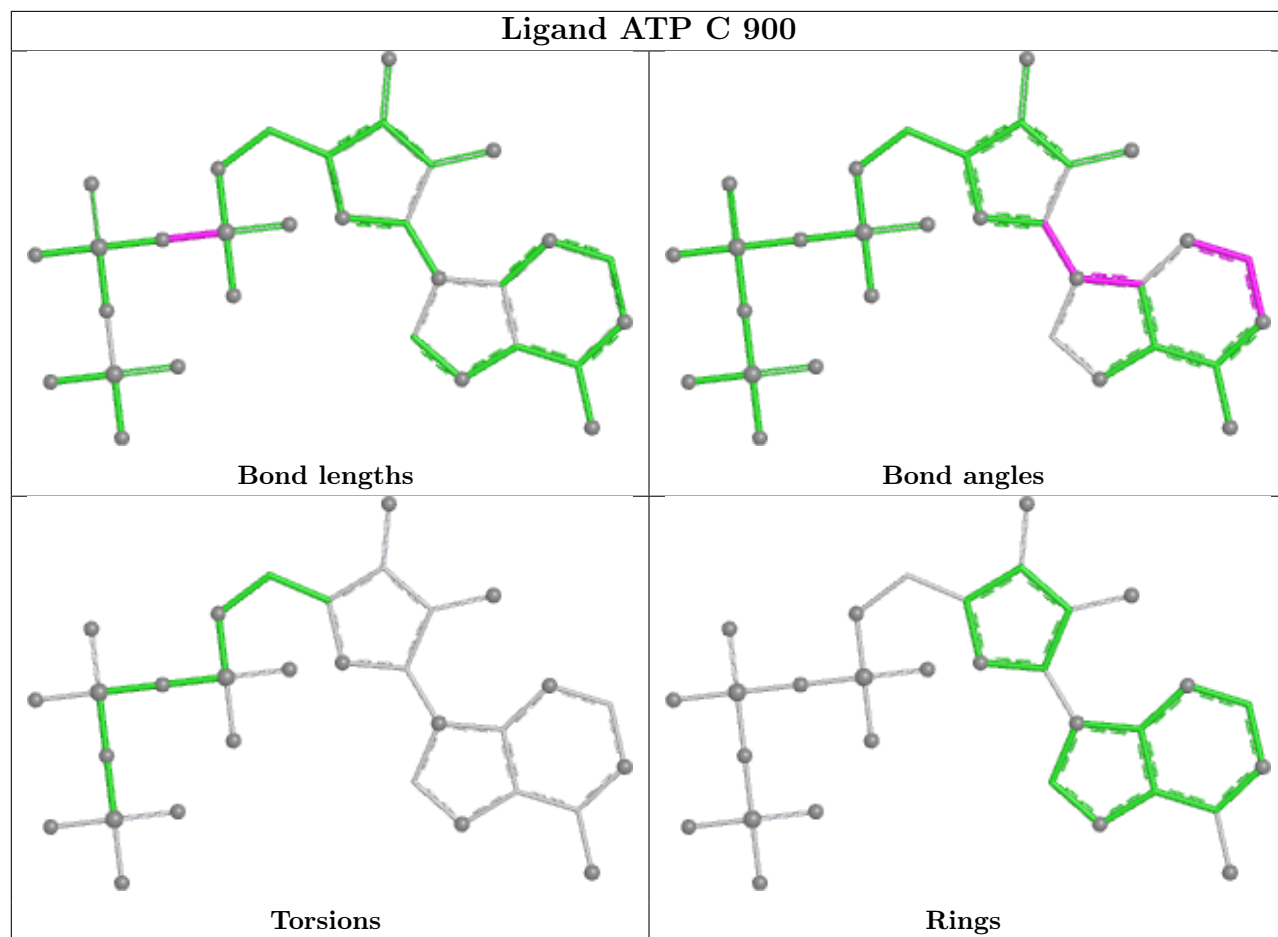

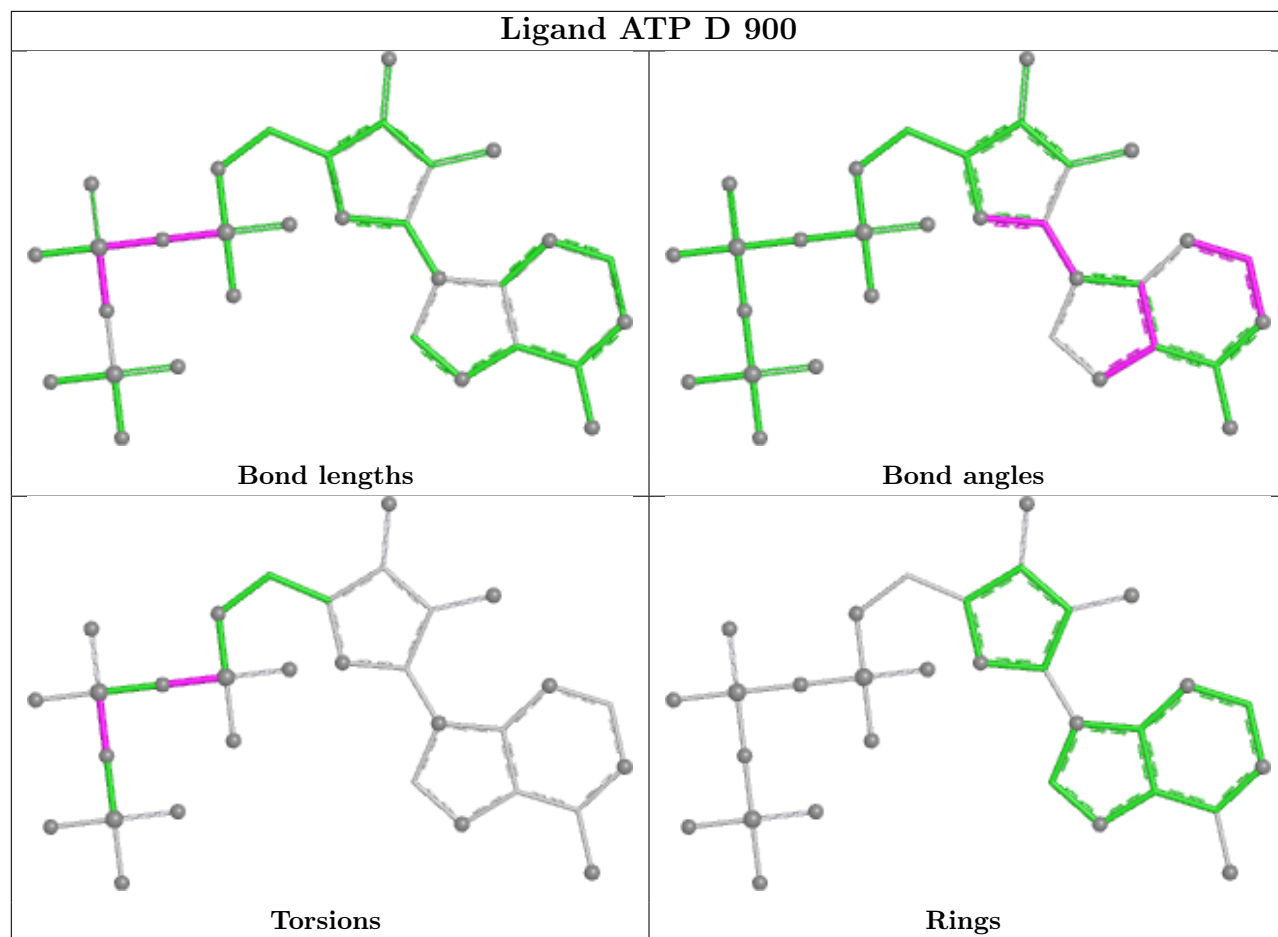



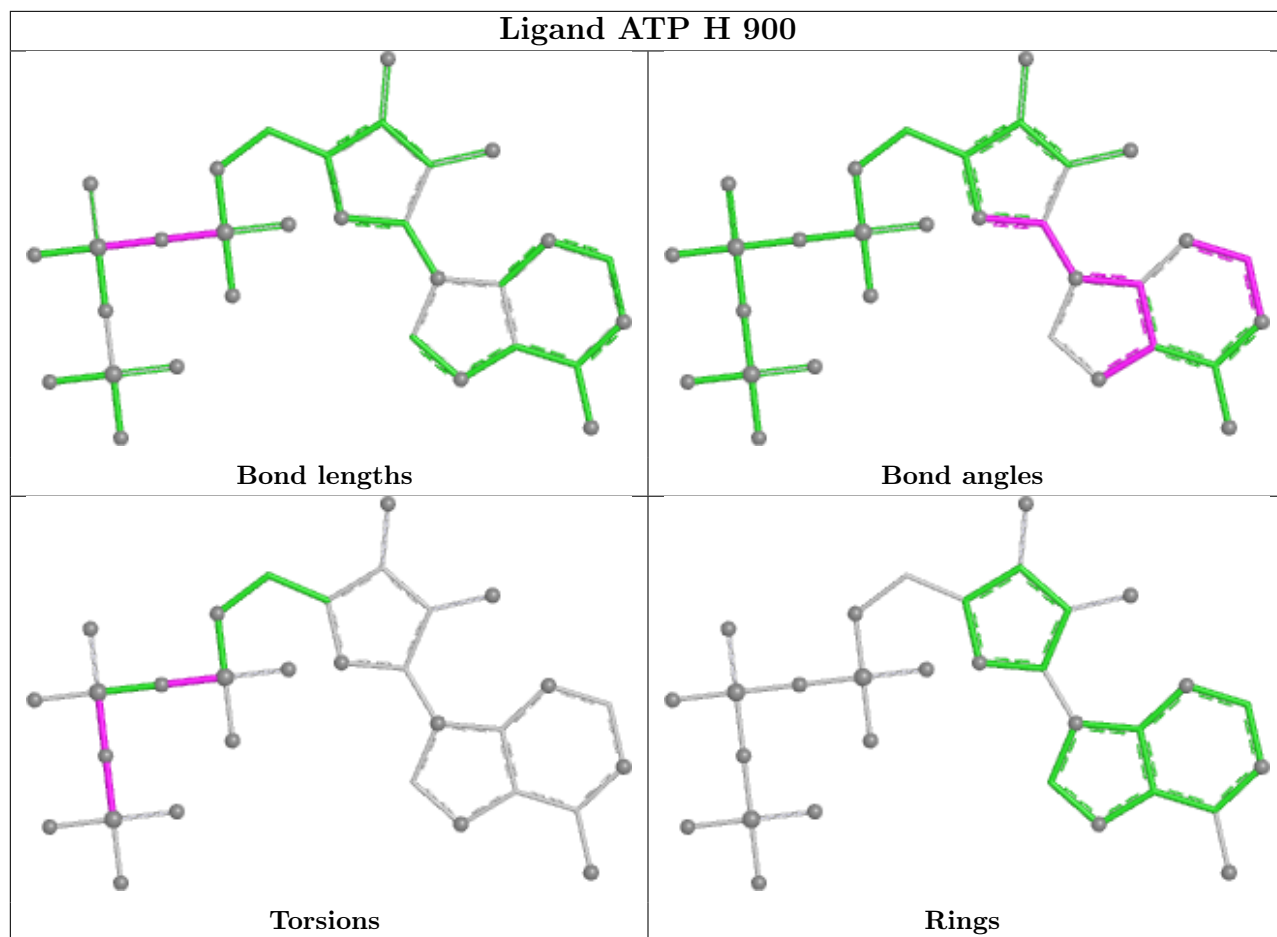

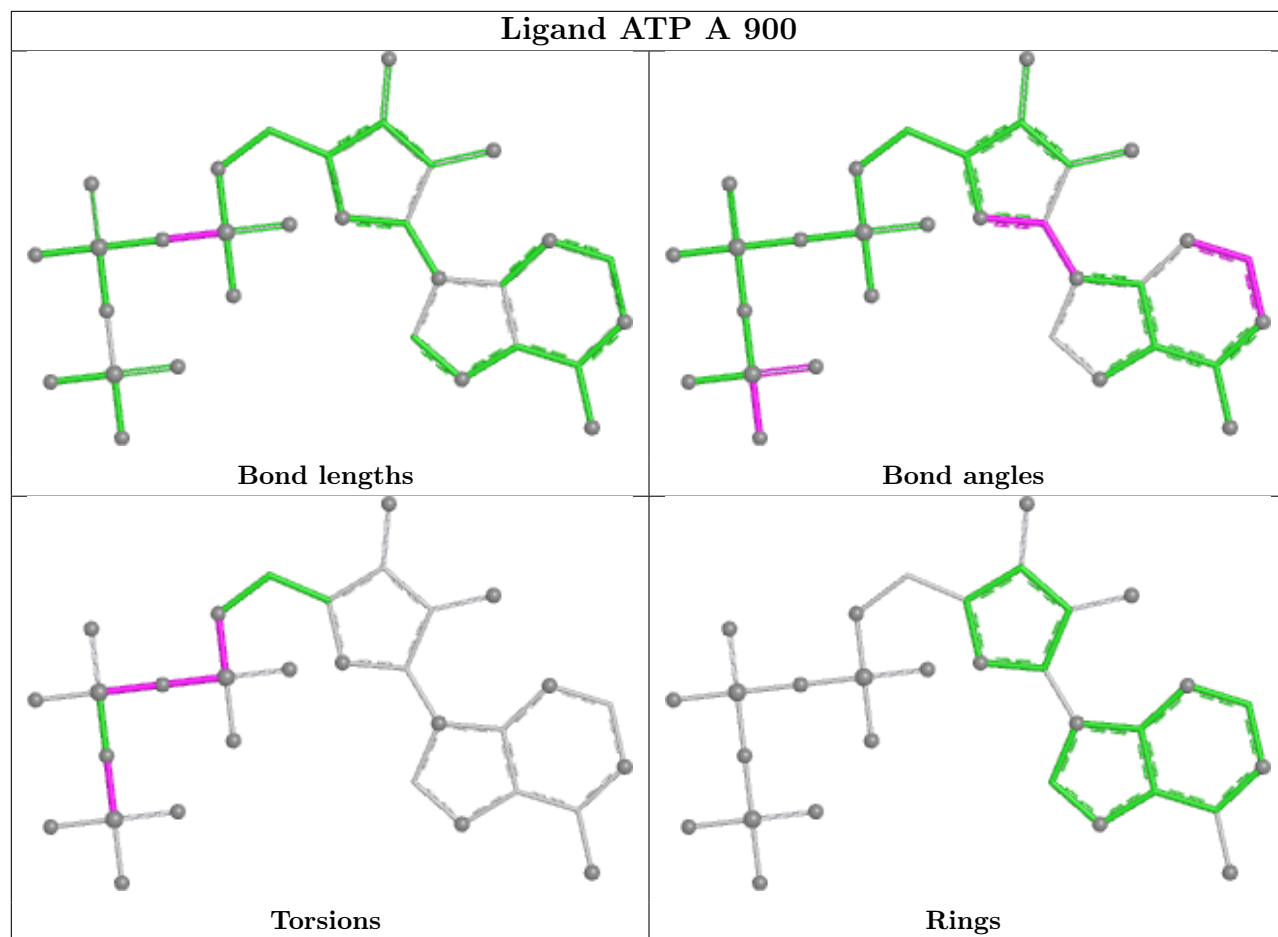

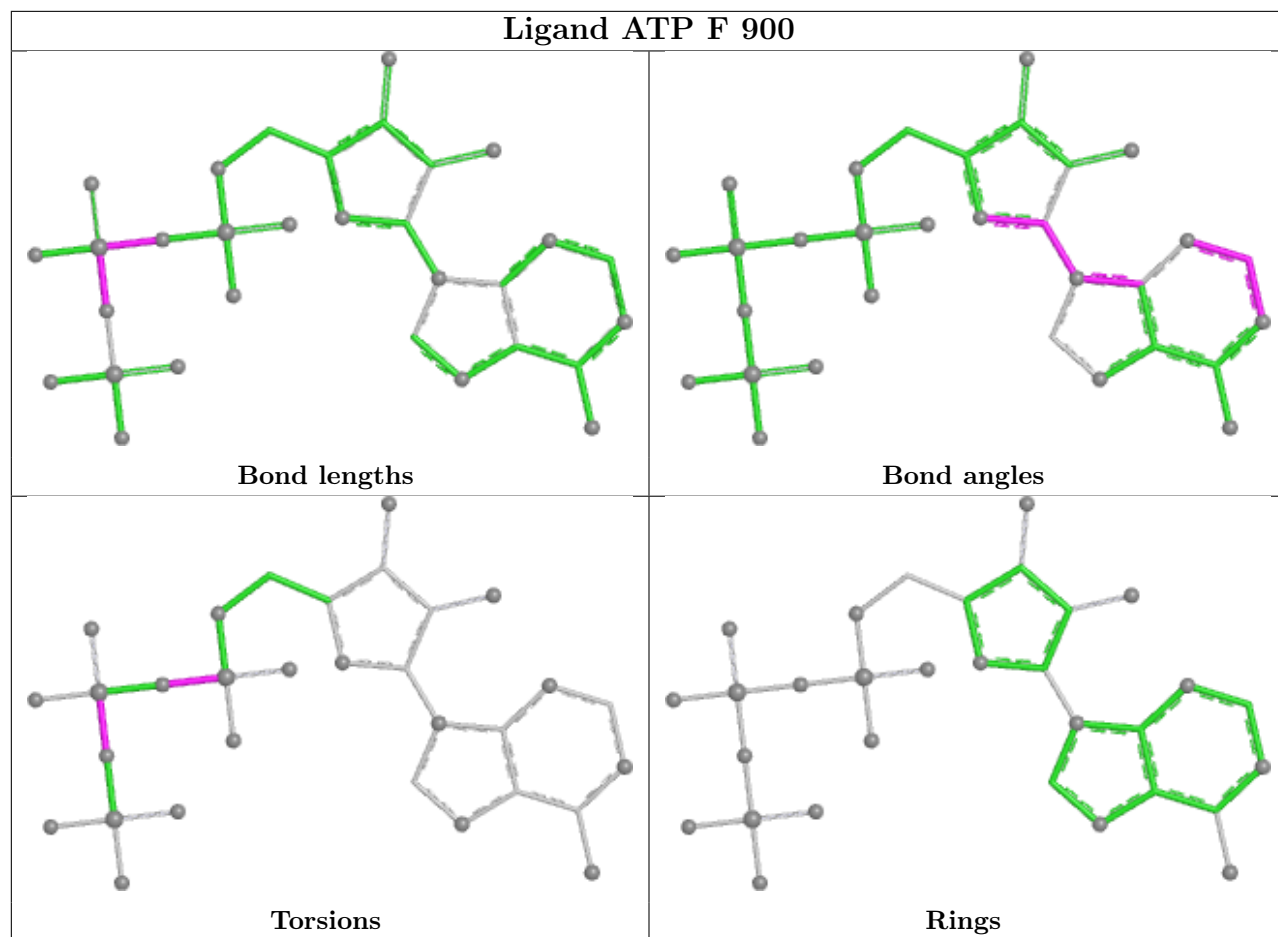

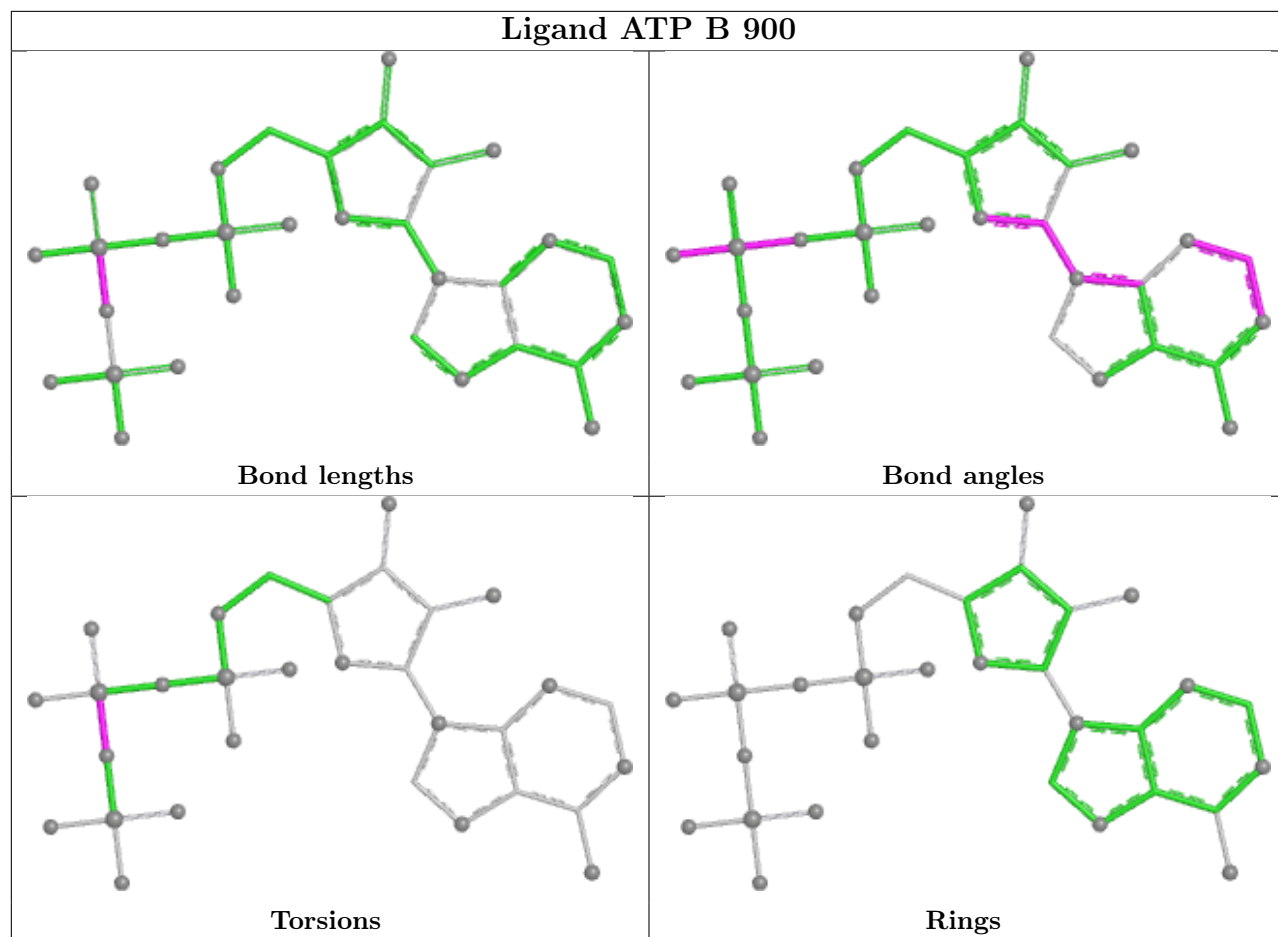

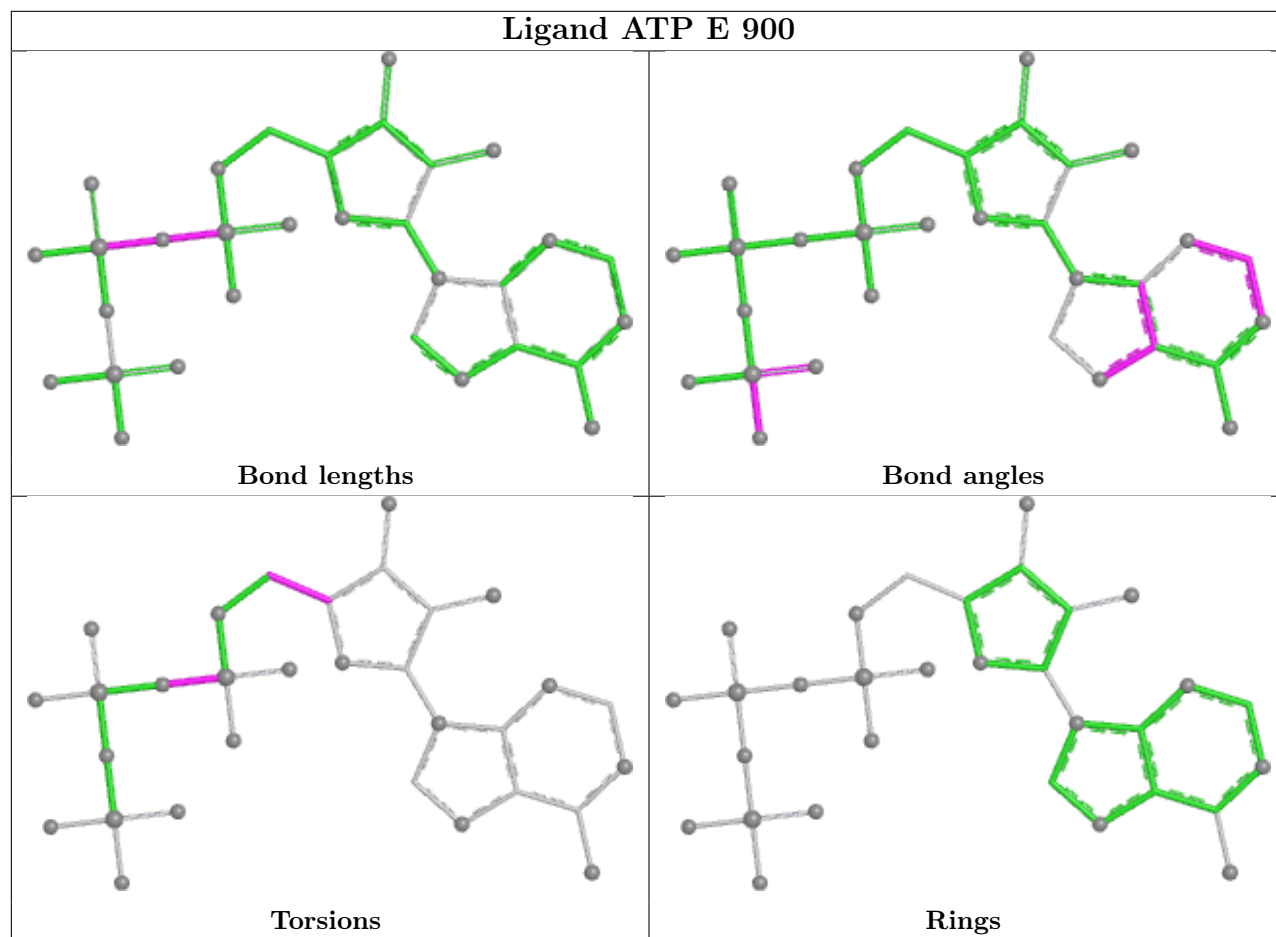

## 5.7 Other polymers [i](#)

There are no such residues in this entry.

## 5.8 Polymer linkage issues [i](#)

There are no chain breaks in this entry.

## 6 Fit of model and data

### 6.1 Protein, DNA and RNA chains

In the following table, the column labelled ‘#RSRZ > 2’ contains the number (and percentage) of RSRZ outliers, followed by percent RSRZ outliers for the chain as percentile scores relative to all X-ray entries and entries of similar resolution. The OWAB column contains the minimum, median, 95<sup>th</sup> percentile and maximum values of the occupancy-weighted average B-factor per residue. The column labelled ‘Q < 0.9’ lists the number of (and percentage) of residues with an average occupancy less than 0.9.

Mol	Chain	Analysed	<RSRZ>	#RSRZ>2	OWAB(Å <sup>2</sup> )	Q<0.9
1	A	396/438 (90%)	0.56	19 (4%) 30 28	23, 52, 110, 169	0
1	B	397/438 (90%)	0.55	25 (6%) 20 18	21, 60, 126, 190	0
1	C	388/438 (88%)	0.74	32 (8%) 11 10	36, 74, 128, 167	0
1	D	398/438 (90%)	0.53	23 (5%) 23 21	27, 58, 115, 167	0
1	E	385/438 (87%)	0.95	53 (13%) 2 2	42, 85, 149, 205	0
1	F	399/438 (91%)	0.60	25 (6%) 20 18	33, 62, 135, 191	0
1	G	388/438 (88%)	0.78	35 (9%) 9 8	30, 75, 131, 180	0
1	H	398/438 (90%)	0.47	20 (5%) 28 26	23, 54, 119, 169	0
All	All	3149/3504 (89%)	0.65	232 (7%) 14 13	21, 64, 130, 205	0

All (232) RSRZ outliers are listed below:

Mol	Chain	Res	Type	RSRZ
1	E	260	ASN	11.6
1	E	363	PRO	7.8
1	H	296	THR	7.7
1	H	295	LEU	7.2
1	C	261	ARG	6.9
1	B	547	VAL	6.8
1	G	454	LEU	6.2
1	D	572	ALA	6.1
1	E	454	LEU	6.0
1	B	260	ASN	5.9
1	E	261	ARG	5.9
1	E	464	LEU	5.9
1	F	354	ILE	5.7
1	E	301	ILE	5.6
1	F	575	LYS	5.5
1	G	295	LEU	5.3

*Continued on next page...*

*Continued from previous page...*

<b>Mol</b>	<b>Chain</b>	<b>Res</b>	<b>Type</b>	<b>RSRZ</b>
1	E	447	THR	5.2
1	B	549	SER	5.1
1	G	451	PRO	5.0
1	E	295	LEU	5.0
1	E	627	LEU	5.0
1	E	467	LYS	4.9
1	F	572	ALA	4.9
1	A	260	ASN	4.9
1	F	606	GLU	4.7
1	A	574	GLY	4.7
1	F	295	LEU	4.7
1	G	301	ILE	4.7
1	E	451	PRO	4.6
1	H	353	PRO	4.6
1	H	215	THR	4.6
1	E	629	LYS	4.5
1	B	261	ARG	4.5
1	C	300	ALA	4.5
1	F	573	ASP	4.4
1	B	296	THR	4.4
1	E	575	LYS	4.3
1	H	572	ALA	4.3
1	B	606	GLU	4.3
1	E	573	ASP	4.2
1	A	295	LEU	4.2
1	G	455	ASN	4.2
1	B	607	THR	4.1
1	E	463	THR	4.0
1	E	352	GLN	4.0
1	G	261	ARG	4.0
1	F	571	ASP	4.0
1	E	420	PHE	3.9
1	H	294	ARG	3.9
1	H	547	VAL	3.9
1	E	299	LYS	3.9
1	A	391	ALA	3.9
1	D	542	GLY	3.9
1	B	551	SER	3.8
1	D	606	GLU	3.8
1	D	551	SER	3.8
1	C	260	ASN	3.8
1	E	319	ILE	3.8

*Continued on next page...*

*Continued from previous page...*

<b>Mol</b>	<b>Chain</b>	<b>Res</b>	<b>Type</b>	<b>RSRZ</b>
1	E	476	VAL	3.8
1	B	301	ILE	3.7
1	D	543	ASP	3.7
1	D	527	ARG	3.7
1	E	572	ALA	3.7
1	C	391	ALA	3.7
1	A	575	LYS	3.6
1	C	295	LEU	3.6
1	C	572	ALA	3.6
1	B	298	GLU	3.5
1	E	384	ILE	3.5
1	H	262	LYS	3.5
1	D	354	ILE	3.5
1	E	391	ALA	3.5
1	C	600	LEU	3.4
1	E	435	PHE	3.4
1	B	572	ALA	3.4
1	F	294	ARG	3.4
1	E	541	ARG	3.4
1	E	461	LEU	3.3
1	G	423	ASN	3.3
1	C	607	THR	3.3
1	C	575	LYS	3.3
1	B	538	ILE	3.3
1	F	262	LYS	3.3
1	F	261	ARG	3.3
1	F	599	LEU	3.3
1	A	423	ASN	3.3
1	E	448	GLY	3.3
1	B	570	VAL	3.2
1	C	571	ASP	3.2
1	C	447	THR	3.2
1	B	550	TRP	3.1
1	G	627	LEU	3.1
1	C	453	HIS	3.1
1	G	603	ARG	3.1
1	D	548	PRO	3.1
1	C	486	GLU	3.1
1	E	468	TYR	3.1
1	C	456	ASN	3.1
1	E	259	SER	3.1
1	C	464	LEU	3.0

*Continued on next page...*



*Continued from previous page...*

<b>Mol</b>	<b>Chain</b>	<b>Res</b>	<b>Type</b>	<b>RSRZ</b>
1	H	571	ASP	3.0
1	G	461	LEU	3.0
1	D	547	VAL	3.0
1	G	486	GLU	3.0
1	E	480	LEU	2.9
1	G	391	ALA	2.9
1	E	455	ASN	2.9
1	E	458	PRO	2.9
1	A	601	THR	2.9
1	F	553	THR	2.9
1	G	572	ALA	2.9
1	B	552	GLU	2.9
1	D	578	LEU	2.9
1	F	578	LEU	2.8
1	H	553	THR	2.8
1	E	443	LEU	2.8
1	F	483	SER	2.8
1	A	486	GLU	2.8
1	G	480	LEU	2.8
1	E	486	GLU	2.7
1	B	575	LYS	2.7
1	E	460	ALA	2.7
1	G	299	LYS	2.7
1	E	274	TYR	2.7
1	G	467	LYS	2.7
1	G	212	GLN	2.7
1	A	576	PRO	2.7
1	D	575	LYS	2.7
1	D	299	LYS	2.7
1	F	574	GLY	2.7
1	C	454	LEU	2.6
1	B	294	ARG	2.6
1	D	549	SER	2.6
1	C	301	ILE	2.6
1	A	542	GLY	2.6
1	F	424	SER	2.6
1	C	455	ASN	2.5
1	E	250	TRP	2.5
1	F	552	GLU	2.5
1	B	608	VAL	2.5
1	E	423	ASN	2.5
1	H	297	ASN	2.5

*Continued on next page...*

*Continued from previous page...*

<b>Mol</b>	<b>Chain</b>	<b>Res</b>	<b>Type</b>	<b>RSRZ</b>
1	D	295	LEU	2.5
1	G	456	ASN	2.5
1	G	300	ALA	2.5
1	H	578	LEU	2.5
1	E	394	LEU	2.5
1	B	571	ASP	2.5
1	D	261	ARG	2.4
1	E	409	LEU	2.4
1	B	299	LYS	2.4
1	C	299	LYS	2.4
1	D	576	PRO	2.4
1	D	570	VAL	2.4
1	C	573	ASP	2.4
1	D	571	ASP	2.4
1	E	625	ASN	2.4
1	B	391	ALA	2.4
1	C	413	ALA	2.4
1	F	576	PRO	2.4
1	D	550	TRP	2.4
1	C	440	LYS	2.4
1	E	438	PHE	2.4
1	E	445	LEU	2.4
1	E	418	VAL	2.4
1	B	354	ILE	2.4
1	E	351	PHE	2.4
1	A	261	ARG	2.4
1	C	451	PRO	2.3
1	G	527	ARG	2.3
1	C	297	ASN	2.3
1	A	559	LEU	2.3
1	E	574	GLY	2.3
1	E	441	LEU	2.3
1	C	307	ASP	2.3
1	H	543	ASP	2.3
1	E	414	ILE	2.3
1	D	607	THR	2.3
1	H	599	LEU	2.3
1	A	301	ILE	2.3
1	H	243	GLY	2.3
1	G	333	LEU	2.3
1	G	539	LEU	2.3
1	F	542	GLY	2.3

*Continued on next page...*

*Continued from previous page...*

<b>Mol</b>	<b>Chain</b>	<b>Res</b>	<b>Type</b>	<b>RSRZ</b>
1	G	538	ILE	2.3
1	A	454	LEU	2.3
1	H	298	GLU	2.3
1	E	421	GLY	2.2
1	C	319	ILE	2.2
1	G	414	ILE	2.2
1	G	452	ALA	2.2
1	B	454	LEU	2.2
1	F	363	PRO	2.2
1	A	614	ARG	2.2
1	F	618	GLN	2.2
1	F	551	SER	2.2
1	C	538	ILE	2.2
1	C	468	TYR	2.2
1	F	485	GLY	2.2
1	E	348	GLU	2.2
1	G	399	ILE	2.2
1	G	351	PHE	2.2
1	H	261	ARG	2.2
1	B	553	THR	2.1
1	A	599	LEU	2.1
1	C	333	LEU	2.1
1	H	594	VAL	2.1
1	E	290	LEU	2.1
1	E	333	LEU	2.1
1	D	428	VAL	2.1
1	G	310	LYS	2.1
1	G	436	VAL	2.1
1	B	319	ILE	2.1
1	G	239	ILE	2.1
1	C	463	THR	2.1
1	G	443	LEU	2.1
1	D	259	SER	2.1
1	G	625	ASN	2.1
1	A	539	LEU	2.1
1	C	267	PHE	2.1
1	E	620	TYR	2.1
1	H	631	SER	2.1
1	A	262	LYS	2.1
1	G	225	ARG	2.1
1	H	575	LYS	2.1
1	D	319	ILE	2.0

*Continued on next page...*

*Continued from previous page...*

Mol	Chain	Res	Type	RSRZ
1	G	290	LEU	2.0
1	G	298	GLU	2.0
1	A	572	ALA	2.0
1	F	436	VAL	2.0
1	F	441	LEU	2.0
1	C	449	THR	2.0

## 6.2 Non-standard residues in protein, DNA, RNA chains [i](#)

There are no non-standard protein/DNA/RNA residues in this entry.

## 6.3 Carbohydrates [i](#)

There are no monosaccharides in this entry.

## 6.4 Ligands [i](#)

In the following table, the Atoms column lists the number of modelled atoms in the group and the number defined in the chemical component dictionary. The B-factors column lists the minimum, median, 95<sup>th</sup> percentile and maximum values of B factors of atoms in the group. The column labelled 'Q< 0.9' lists the number of atoms with occupancy less than 0.9.

Mol	Type	Chain	Res	Atoms	RSCC	RSR	B-factors(Å <sup>2</sup> )	Q<0.9
3	MG	B	1000	1/1	0.79	0.15	38,38,38,38	0
3	MG	H	1000	1/1	0.79	0.21	42,42,42,42	0
3	MG	C	1000	1/1	0.86	0.24	56,56,56,56	0
3	MG	E	1000	1/1	0.88	0.22	54,54,54,54	0
2	ATP	E	900	31/31	0.92	0.18	39,60,79,122	0
3	MG	A	1000	1/1	0.93	0.35	41,41,41,41	0
3	MG	F	1000	1/1	0.94	0.14	52,52,52,52	0
2	ATP	C	900	31/31	0.94	0.20	32,50,71,128	0
3	MG	D	1000	1/1	0.95	0.20	29,29,29,29	0
3	MG	G	1000	1/1	0.95	0.28	52,52,52,52	0
2	ATP	G	900	31/31	0.95	0.20	35,51,73,158	0
2	ATP	A	900	31/31	0.96	0.26	22,35,69,135	0
2	ATP	F	900	31/31	0.97	0.16	34,46,59,67	0
2	ATP	B	900	31/31	0.97	0.17	30,42,62,76	0
2	ATP	D	900	31/31	0.98	0.19	19,36,43,50	0
2	ATP	H	900	31/31	0.98	0.17	25,39,50,60	0

The following is a graphical depiction of the model fit to experimental electron density of all instances of the Ligand of Interest. In addition, ligands with molecular weight > 250 and outliers as shown on the geometry validation Tables will also be included. Each fit is shown from different orientation to approximate a three-dimensional view.

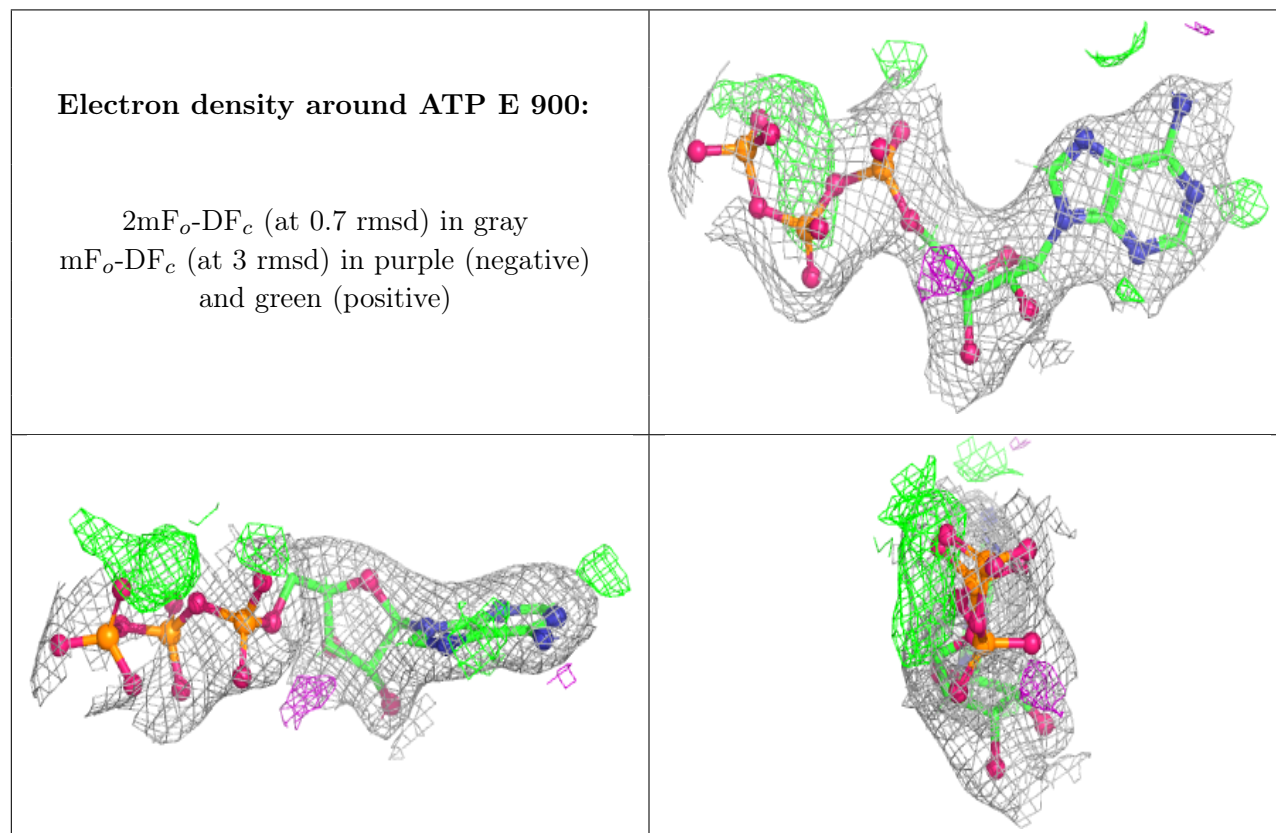

**Electron density around ATP C 900:**

$2mF_o-DF_c$  (at 0.7 rmsd) in gray  
 $mF_o-DF_c$  (at 3 rmsd) in purple (negative)  
and green (positive)

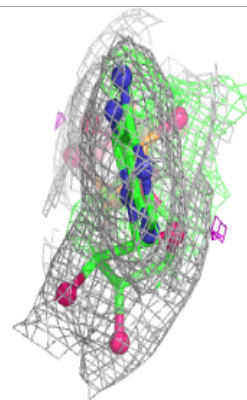
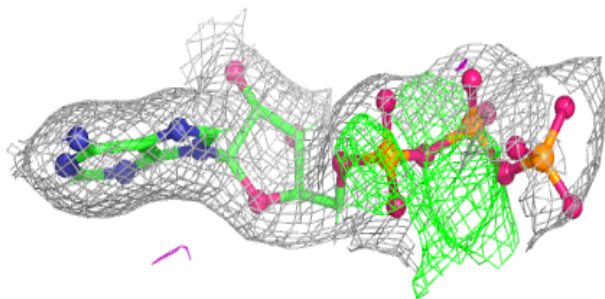
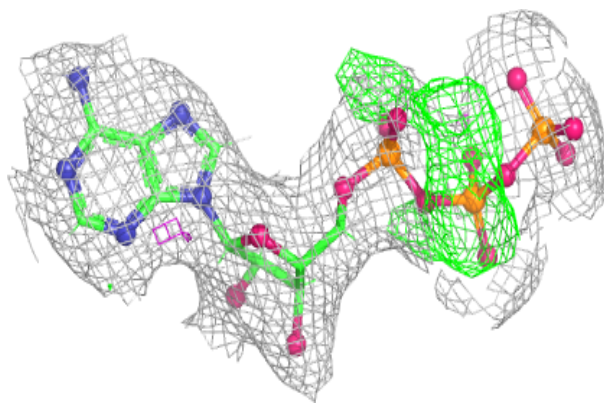
**Electron density around ATP G 900:**

$2mF_o-DF_c$  (at 0.7 rmsd) in gray  
 $mF_o-DF_c$  (at 3 rmsd) in purple (negative)  
and green (positive)

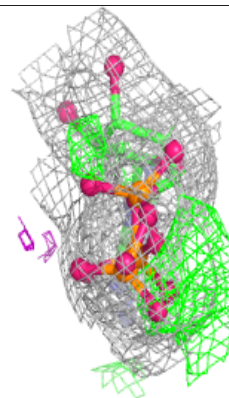
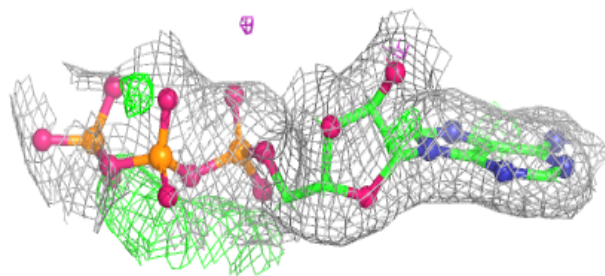
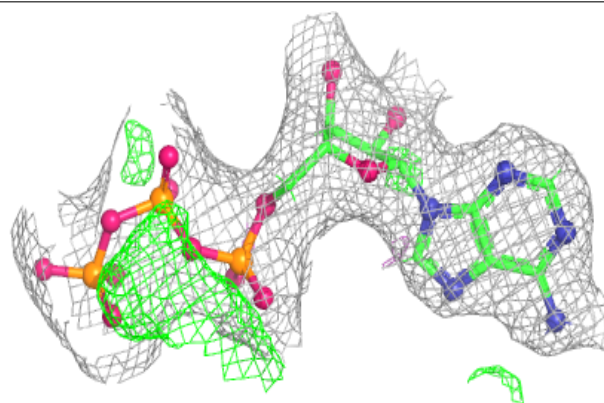

**Electron density around ATP A 900:**

$2mF_o-DF_c$  (at 0.7 rmsd) in gray  
 $mF_o-DF_c$  (at 3 rmsd) in purple (negative)  
and green (positive)

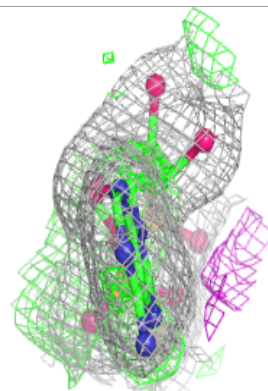
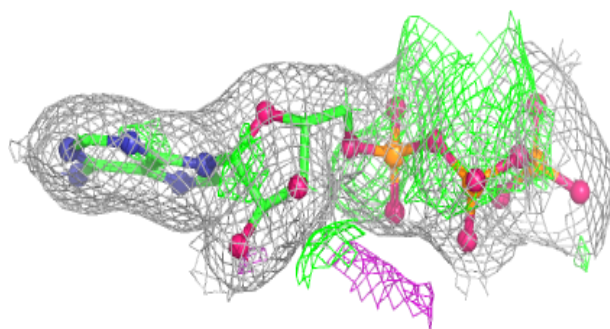
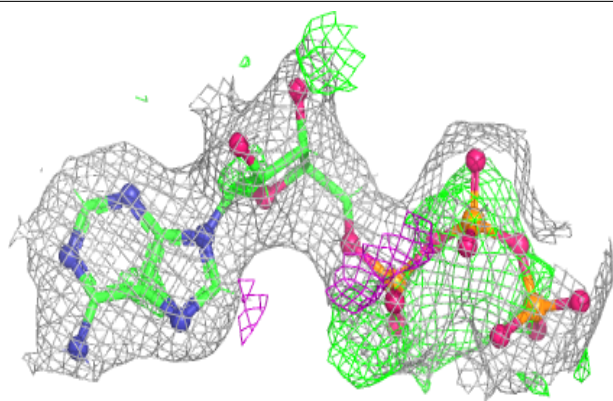
**Electron density around ATP F 900:**

$2mF_o-DF_c$  (at 0.7 rmsd) in gray  
 $mF_o-DF_c$  (at 3 rmsd) in purple (negative)  
and green (positive)

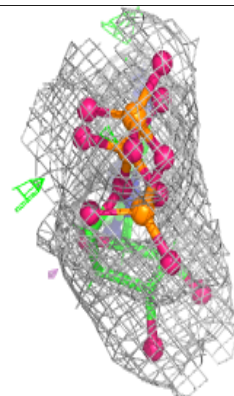
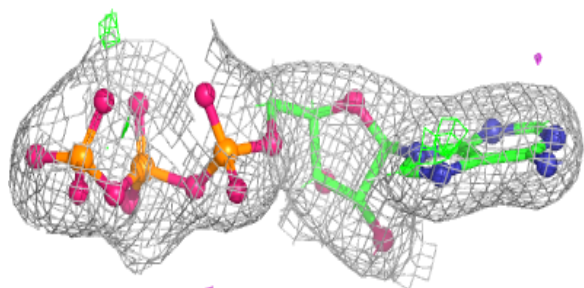
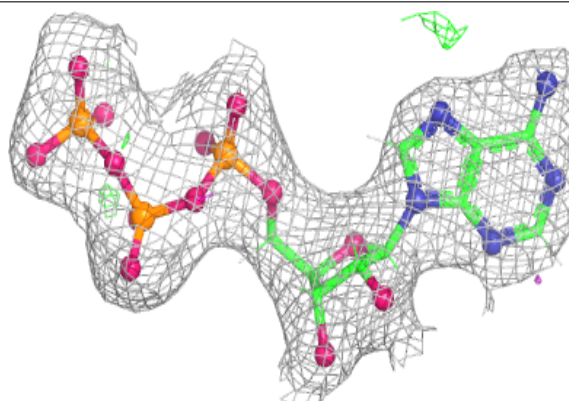

**Electron density around ATP B 900:**

$2mF_o-DF_c$  (at 0.7 rmsd) in gray  
 $mF_o-DF_c$  (at 3 rmsd) in purple (negative)  
and green (positive)

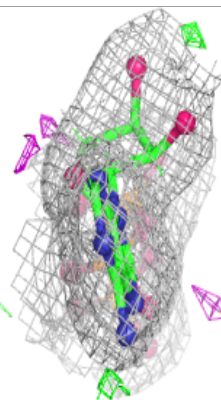
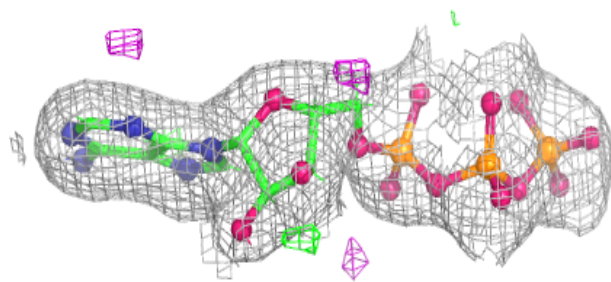
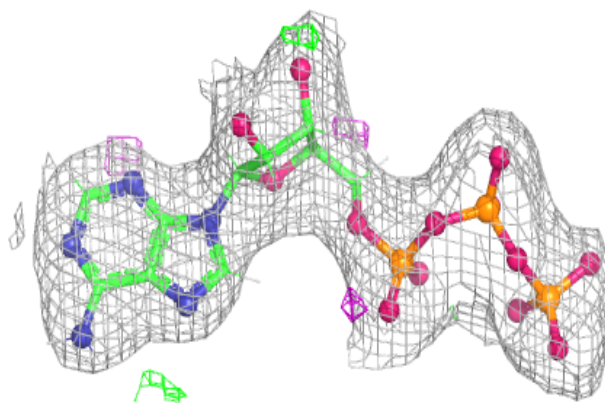
**Electron density around ATP D 900:**

$2mF_o-DF_c$  (at 0.7 rmsd) in gray  
 $mF_o-DF_c$  (at 3 rmsd) in purple (negative)  
and green (positive)

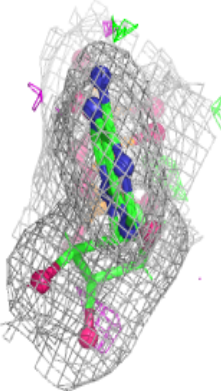
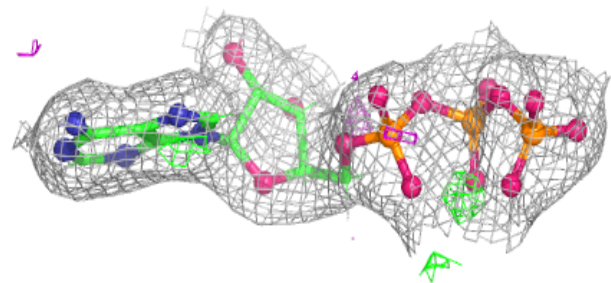
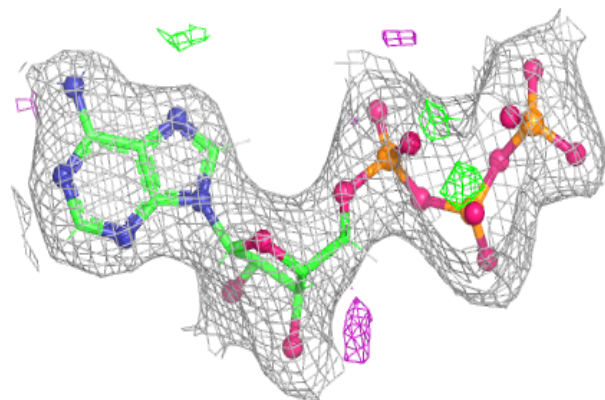



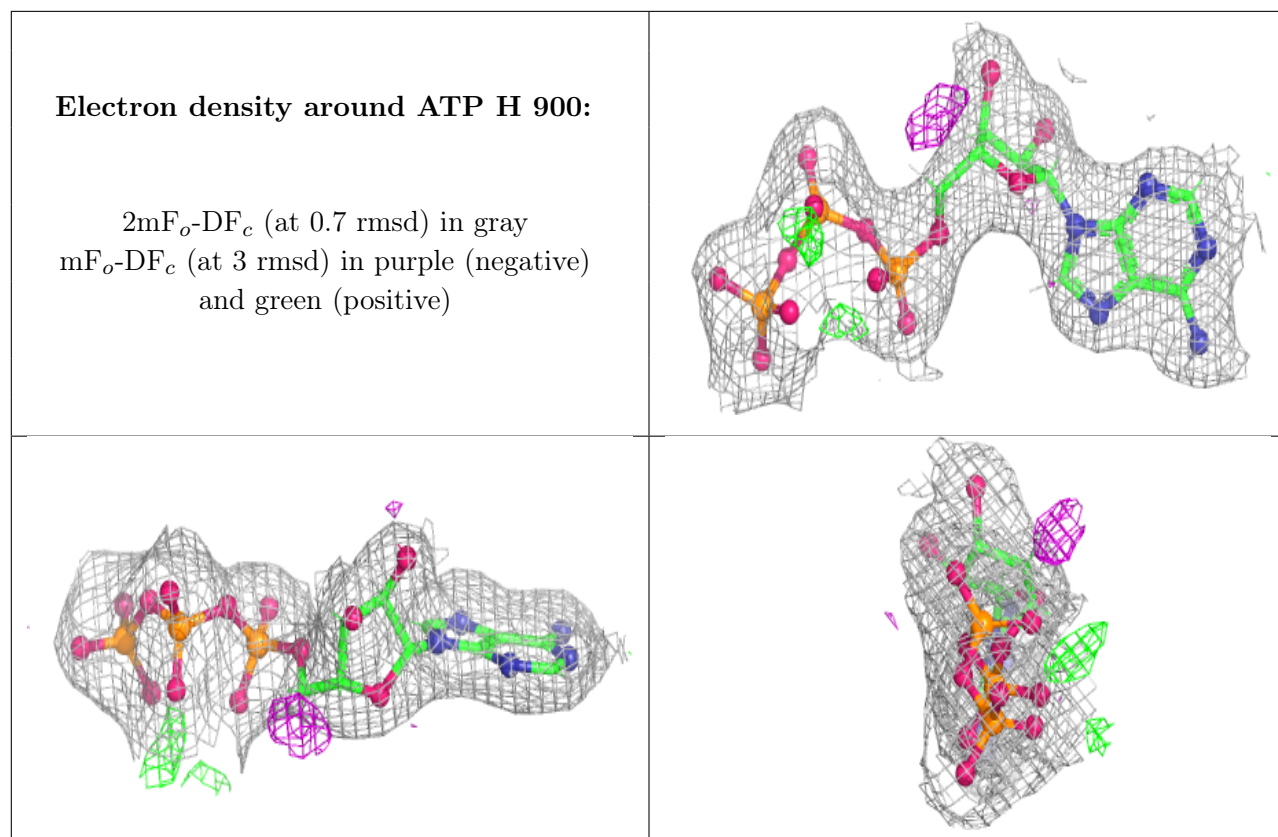

## 6.5 Other polymers [i](#)

There are no such residues in this entry.