



Full wwPDB X-ray Structure Validation Report ⓘ

Jun 12, 2024 – 07:14 PM EDT

PDB ID : 3WD6
Title : Crystal structure of Bombyx mori omega-class glutathione transferase in complex with GSH
Authors : Yamamoto, K.; Suzuki, M.; Higashiura, A.; Nakagawa, A.
Deposited on : 2013-06-07
Resolution : 2.50 Å(reported)

This is a Full wwPDB X-ray Structure Validation Report for a publicly released PDB entry.

We welcome your comments at validation@mail.wwpdb.org

A user guide is available at

<https://www.wwpdb.org/validation/2017/XrayValidationReportHelp>

with specific help available everywhere you see the ⓘ symbol.

The types of validation reports are described at

<http://www.wwpdb.org/validation/2017/FAQs#types>.

The following versions of software and data (see [references ⓘ](#)) were used in the production of this report:

MolProbity : 4.02b-467
Mogul : 2022.3.0, CSD as543be (2022)
Xtriage (Phenix) : 1.20.1
EDS : 2.36.2
buster-report : 1.1.7 (2018)
Percentile statistics : 20191225.v01 (using entries in the PDB archive December 25th 2019)
Refmac : 5.8.0158
CCP4 : 7.0.044 (Gargrove)
Ideal geometry (proteins) : Engh & Huber (2001)
Ideal geometry (DNA, RNA) : Parkinson et al. (1996)
Validation Pipeline (wwPDB-VP) : 2.36.2

1 Overall quality at a glance

The following experimental techniques were used to determine the structure:

X-RAY DIFFRACTION

The reported resolution of this entry is 2.50 Å.

Percentile scores (ranging between 0-100) for global validation metrics of the entry are shown in the following graphic. The table shows the number of entries on which the scores are based.

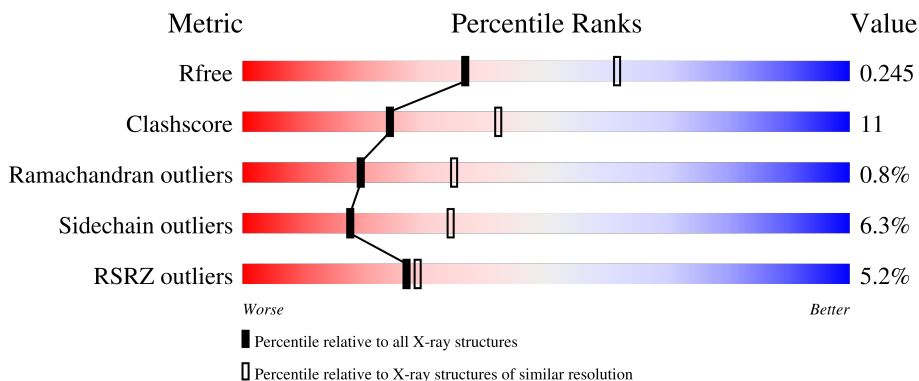

Metric	Whole archive (#Entries)	Similar resolution (#Entries, resolution range(Å))
R_{free}	130704	4661 (2.50-2.50)
Clashscore	141614	5346 (2.50-2.50)
Ramachandran outliers	138981	5231 (2.50-2.50)
Sidechain outliers	138945	5233 (2.50-2.50)
RSRZ outliers	127900	4559 (2.50-2.50)

The table below summarises the geometric issues observed across the polymeric chains and their fit to the electron density. The red, orange, yellow and green segments of the lower bar indicate the fraction of residues that contain outliers for ≥ 3 , 2, 1 and 0 types of geometric quality criteria respectively. A grey segment represents the fraction of residues that are not modelled. The numeric value for each fraction is indicated below the corresponding segment, with a dot representing fractions $\leq 5\%$. The upper red bar (where present) indicates the fraction of residues that have poor fit to the electron density. The numeric value is given above the bar.

Mol	Chain	Length	Quality of chain
1	A	256	 2% 78% 15% • 5%
1	B	256	 2% 73% 18% • 6%
1	C	256	 9% 64% 27% • 6%
1	D	256	 7% 59% 32% • 5%

The following table lists non-polymeric compounds, carbohydrate monomers and non-standard

residues in protein, DNA, RNA chains that are outliers for geometric or electron-density-fit criteria:

Mol	Type	Chain	Res	Chirality	Geometry	Clashes	Electron density
4	PEG	A	305	-	-	X	-

2 Entry composition [i](#)

There are 7 unique types of molecules in this entry. The entry contains 8416 atoms, of which 0 are hydrogens and 0 are deuteriums.

In the tables below, the ZeroOcc column contains the number of atoms modelled with zero occupancy, the AltConf column contains the number of residues with at least one atom in alternate conformation and the Trace column contains the number of residues modelled with at most 2 atoms.

- Molecule 1 is a protein called Omega-class glutathione S-transferase.

Mol	Chain	Residues	Atoms					ZeroOcc	AltConf	Trace
			Total	C	N	O	S			
1	A	242	1996	1300	327	365	4	0	0	0
1	B	241	1988	1296	325	363	4	0	0	0
1	C	241	1988	1296	325	363	4	0	0	0
1	D	242	1996	1300	327	365	4	0	0	0

- Molecule 2 is POTASSIUM ION (three-letter code: K) (formula: K).

Mol	Chain	Residues	Atoms		ZeroOcc	AltConf
2	A	3	Total 3	K 3	0	0
2	B	2	Total 2	K 2	0	0
2	C	2	Total 2	K 2	0	0
2	D	1	Total 1	K 1	0	0

- Molecule 3 is 1,2-ETHANEDIOL (three-letter code: EDO) (formula: C₂H₆O₂).



Mol	Chain	Residues	Atoms	ZeroOcc	AltConf
3	A	1	Total C O 4 2 2	0	0
3	B	1	Total C O 4 2 2	0	0
3	C	1	Total C O 4 2 2	0	0
3	C	1	Total C O 4 2 2	0	0
3	D	1	Total C O 4 2 2	0	0

- Molecule 4 is DI(HYDROXYETHYL)ETHER (three-letter code: PEG) (formula: C₄H₁₀O₃).

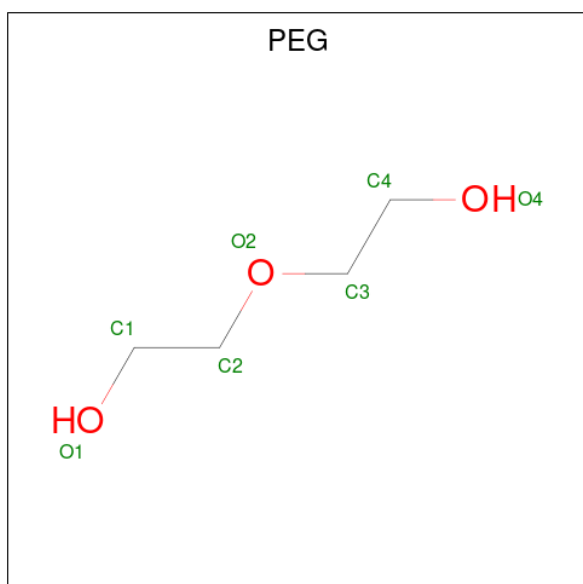

Mol	Chain	Residues	Atoms			ZeroOcc	AltConf
4	A	1	Total	C	O	0	0
			7	4	3		

- Molecule 5 is GLUTATHIONE (three-letter code: GSH) (formula: C₁₀H₁₇N₃O₆S).

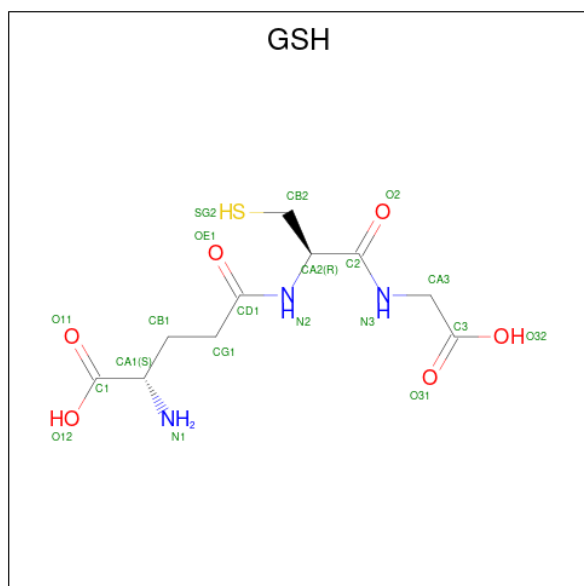

Mol	Chain	Residues	Atoms					ZeroOcc	AltConf
5	A	1	Total	C	N	O	S	0	0
			20	10	3	6	1		
5	B	1	Total	C	N	O	S	0	0
			20	10	3	6	1		
5	C	1	Total	C	N	O	S	0	0
			20	10	3	6	1		
5	D	1	Total	C	N	O	S	0	0
			20	10	3	6	1		

- Molecule 6 is IODIDE ION (three-letter code: IOD) (formula: I).

Mol	Chain	Residues	Atoms		ZeroOcc	AltConf
6	C	1	Total	I	0	0
			1	1		
6	D	1	Total	I	0	0
			1	1		

- Molecule 7 is water.

Mol	Chain	Residues	Atoms		ZeroOcc	AltConf
7	A	112	Total 112	O 112	0	0
7	B	129	Total 129	O 129	0	0
7	C	40	Total 40	O 40	0	0
7	D	50	Total 50	O 50	0	0

3 Residue-property plots [i](#)

These plots are drawn for all protein, RNA, DNA and oligosaccharide chains in the entry. The first graphic for a chain summarises the proportions of the various outlier classes displayed in the second graphic. The second graphic shows the sequence view annotated by issues in geometry and electron density. Residues are color-coded according to the number of geometric quality criteria for which they contain at least one outlier: green = 0, yellow = 1, orange = 2 and red = 3 or more. A red dot above a residue indicates a poor fit to the electron density ($RSRZ > 2$). Stretches of 2 or more consecutive residues without any outlier are shown as a green connector. Residues present in the sample, but not in the model, are shown in grey.

- Molecule 1: Omega-class glutathione S-transferase

Chain A: 

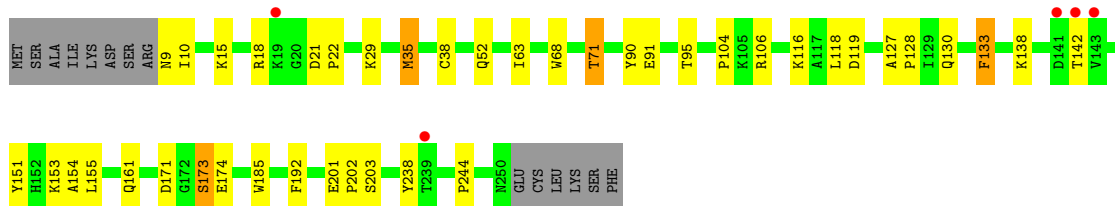

- Molecule 1: Omega-class glutathione S-transferase

Chain B: 

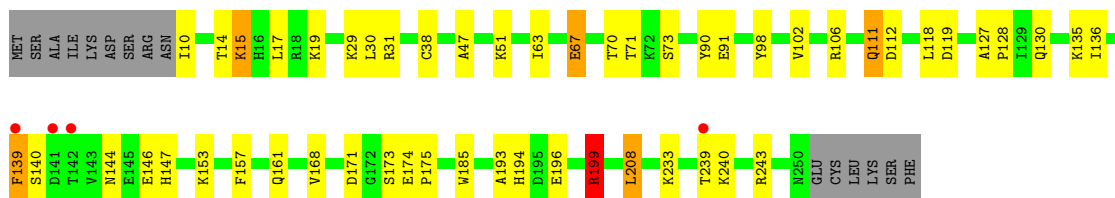

- Molecule 1: Omega-class glutathione S-transferase

Chain C: 

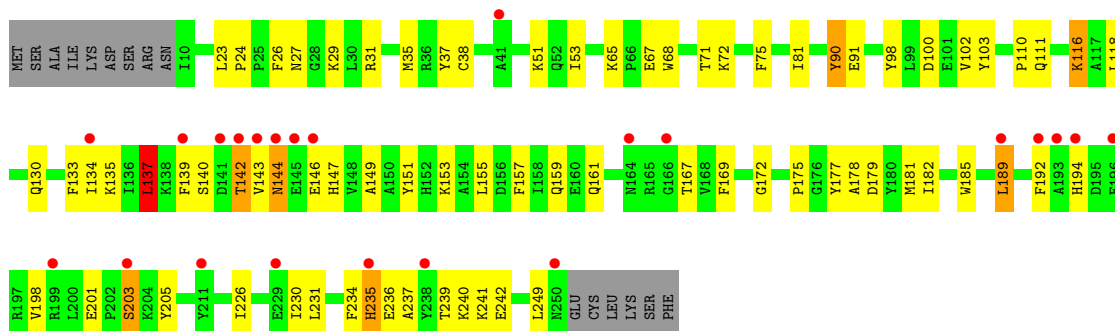

- Molecule 1: Omega-class glutathione S-transferase

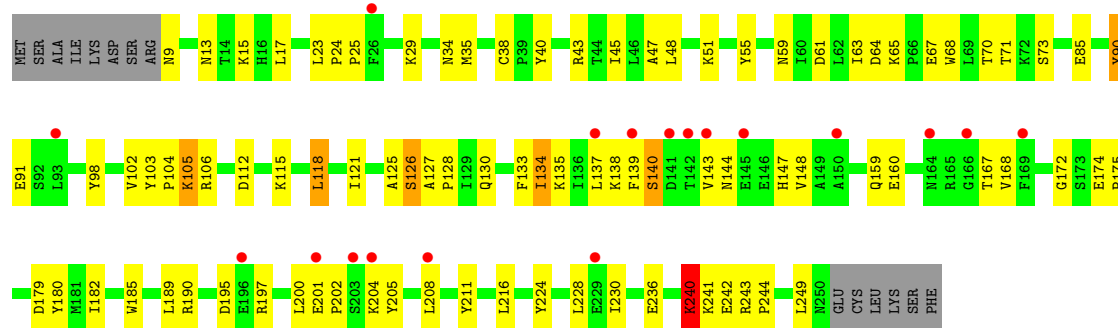

4 Data and refinement statistics

Property	Value	Source
Space group	P 2 21 21	Depositor
Cell constants a, b, c, α , β , γ	75.86Å 89.89Å 182.15Å 90.00° 90.00° 90.00°	Depositor
Resolution (Å)	32.84 – 2.50 32.84 – 2.50	Depositor EDS
% Data completeness (in resolution range)	99.8 (32.84-2.50) 99.9 (32.84-2.50)	Depositor EDS
R_{merge}	(Not available)	Depositor
R_{sym}	(Not available)	Depositor
$\langle I/\sigma(I) \rangle$ ¹	2.54 (at 2.51Å)	Xtrriage
Refinement program	PHENIX (phenix.refine: 1.7.1_743)	Depositor
R, R_{free}	0.208 , 0.256 0.201 , 0.245	Depositor DCC
R_{free} test set	2191 reflections (5.00%)	wwPDB-VP
Wilson B-factor (Å ²)	32.1	Xtrriage
Anisotropy	0.223	Xtrriage
Bulk solvent k_{sol} (e/Å ³), B_{sol} (Å ²)	0.33 , 46.3	EDS
L-test for twinning ²	$\langle L \rangle = 0.50$, $\langle L^2 \rangle = 0.33$	Xtrriage
Estimated twinning fraction	No twinning to report.	Xtrriage
F_o, F_c correlation	0.93	EDS
Total number of atoms	8416	wwPDB-VP
Average B, all atoms (Å ²)	40.0	wwPDB-VP

Xtrriage's analysis on translational NCS is as follows: *The analyses of the Patterson function reveals a significant off-origin peak that is 20.31 % of the origin peak, indicating pseudo-translational symmetry. The chance of finding a peak of this or larger height randomly in a structure without pseudo-translational symmetry is equal to 8.9401e-03. The detected translational NCS is most likely also responsible for the elevated intensity ratio.*

¹Intensities estimated from amplitudes.

²Theoretical values of $\langle |L| \rangle$, $\langle L^2 \rangle$ for acentric reflections are 0.5, 0.333 respectively for untwinned datasets, and 0.375, 0.2 for perfectly twinned datasets.

5 Model quality [i](#)

5.1 Standard geometry [i](#)

Bond lengths and bond angles in the following residue types are not validated in this section: PEG, IOD, K, EDO, GSH

The Z score for a bond length (or angle) is the number of standard deviations the observed value is removed from the expected value. A bond length (or angle) with $|Z| > 5$ is considered an outlier worth inspection. RMSZ is the root-mean-square of all Z scores of the bond lengths (or angles).

Mol	Chain	Bond lengths		Bond angles	
		RMSZ	# Z >5	RMSZ	# Z >5
1	A	0.54	0/2047	0.56	0/2781
1	B	0.55	0/2039	0.57	0/2770
1	C	0.37	0/2039	0.52	0/2770
1	D	0.40	0/2047	0.51	0/2781
All	All	0.47	0/8172	0.54	0/11102

There are no bond length outliers.

There are no bond angle outliers.

There are no chirality outliers.

There are no planarity outliers.

5.2 Too-close contacts [i](#)

In the following table, the Non-H and H(model) columns list the number of non-hydrogen atoms and hydrogen atoms in the chain respectively. The H(added) column lists the number of hydrogen atoms added and optimized by MolProbity. The Clashes column lists the number of clashes within the asymmetric unit, whereas Symm-Clashes lists symmetry-related clashes.

Mol	Chain	Non-H	H(model)	H(added)	Clashes	Symm-Clashes
1	A	1996	0	2010	35	0
1	B	1988	0	2004	40	0
1	C	1988	0	2004	44	0
1	D	1996	0	2010	62	0
2	A	3	0	0	0	0
2	B	2	0	0	0	0
2	C	2	0	0	0	0
2	D	1	0	0	0	0
3	A	4	0	6	2	0

Continued on next page...

Continued from previous page...

Mol	Chain	Non-H	H(model)	H(added)	Clashes	Symm-Clashes
3	B	4	0	6	1	0
3	C	8	0	12	4	0
3	D	4	0	6	0	0
4	A	7	0	10	5	0
5	A	20	0	15	3	0
5	B	20	0	15	2	0
5	C	20	0	15	2	0
5	D	20	0	15	3	0
6	C	1	0	0	0	0
6	D	1	0	0	0	0
7	A	112	0	0	6	0
7	B	129	0	0	4	0
7	C	40	0	0	2	0
7	D	50	0	0	1	0
All	All	8416	0	8128	179	0

The all-atom clashscore is defined as the number of clashes found per 1000 atoms (including hydrogen atoms). The all-atom clashscore for this structure is 11.

All (179) close contacts within the same asymmetric unit are listed below, sorted by their clash magnitude.

Atom-1	Atom-2	Interatomic distance (Å)	Clash overlap (Å)
1:A:38:CYS:HG	5:A:306:GSH:HSG	0.97	0.93
1:B:38:CYS:HG	5:B:304:GSH:HSG	0.95	0.89
1:D:38:CYS:HG	5:D:304:GSH:HSG	0.97	0.88
1:A:171:ASP:HB3	4:A:305:PEG:H32	1.57	0.86
1:C:51:LYS:NZ	1:C:103:TYR:O	2.11	0.83
1:B:239:THR:O	1:B:240:LYS:HB2	1.81	0.79
1:B:111:GLN:NE2	1:B:111:GLN:H	1.82	0.76
1:B:67:GLU:H	1:B:67:GLU:CD	1.91	0.74
1:D:61:ASP:OD2	1:D:243:ARG:NH2	2.21	0.74
1:A:138:LYS:HE2	1:A:238:TYR:CE2	2.24	0.73
1:D:138:LYS:O	1:D:241:LYS:NZ	2.21	0.73
1:A:161:GLN:NE2	7:A:450:HOH:O	2.21	0.73
1:B:196:GLU:CD	1:B:196:GLU:H	1.91	0.72
1:B:144:ASN:HB3	1:B:146:GLU:H	1.56	0.71
1:C:144:ASN:HB2	1:C:147:HIS:CD2	2.26	0.71
1:C:135:LYS:HE3	1:C:147:HIS:CE1	2.27	0.69
1:C:110:PRO:O	1:C:116:LYS:NZ	2.28	0.66
1:D:137:LEU:HD23	1:D:138:LYS:HG3	1.77	0.66
1:B:111:GLN:H	1:B:111:GLN:CD	1.99	0.66

Continued on next page...

Continued from previous page...

Atom-1	Atom-2	Interatomic distance (Å)	Clash overlap (Å)
1:D:68:TRP:O	1:D:71:THR:HB	1.95	0.66
1:B:111:GLN:HG2	1:B:112:ASP:N	2.11	0.66
1:D:38:CYS:SG	5:D:304:GSH:SG2	2.75	0.66
1:C:51:LYS:HE3	1:C:100:ASP:HA	1.77	0.65
1:A:106:ARG:NH2	4:A:305:PEG:H11	2.13	0.64
1:A:116:LYS:NZ	7:A:442:HOH:O	2.29	0.64
1:C:135:LYS:HE3	1:C:147:HIS:HE1	1.63	0.64
1:C:65:LYS:NZ	5:C:306:GSH:O31	2.23	0.64
1:D:143:VAL:HG12	1:D:144:ASN:H	1.62	0.63
1:C:139:PHE:HB3	1:C:142:THR:OG1	1.99	0.63
1:C:90:TYR:O	1:C:91:GLU:HB2	1.99	0.63
1:B:173:SER:HB2	7:B:522:HOH:O	1.98	0.63
1:D:208:LEU:O	1:D:211:TYR:HB3	1.99	0.62
1:C:230:ILE:HG21	1:C:249:LEU:HD21	1.82	0.62
1:D:64:ASP:OD2	1:D:243:ARG:NH1	2.33	0.61
1:B:139:PHE:HE2	7:B:523:HOH:O	1.81	0.61
1:D:38:CYS:CB	5:D:304:GSH:HSG	2.13	0.61
1:B:106:ARG:NH2	1:B:175:PRO:O	2.33	0.61
1:D:243:ARG:HD2	1:D:244:PRO:HD2	1.83	0.60
1:C:26:PHE:HB2	3:C:304:EDO:H12	1.82	0.60
1:D:105:LYS:HE2	1:D:105:LYS:H	1.66	0.59
1:A:29:LYS:HE2	1:B:194:HIS:CD2	2.38	0.59
1:C:159:GLN:OE1	1:C:205:TYR:HA	2.03	0.59
1:D:127:ALA:HB3	1:D:128:PRO:HD3	1.84	0.58
1:A:138:LYS:HE2	1:A:238:TYR:CD2	2.38	0.58
1:B:38:CYS:HG	5:B:304:GSH:CB2	2.15	0.58
1:A:68:TRP:O	1:A:71:THR:HB	2.03	0.58
1:C:68:TRP:CD1	3:C:305:EDO:H11	2.39	0.57
1:A:90:TYR:O	1:A:91:GLU:HB2	2.05	0.56
1:D:195:ASP:OD2	1:D:197:ARG:NH2	2.35	0.56
1:D:15:LYS:HD2	1:D:17:LEU:HD23	1.88	0.56
1:D:201:GLU:HB3	1:D:204:LYS:HB2	1.87	0.56
1:A:104:PRO:HD2	7:A:494:HOH:O	2.06	0.55
1:C:68:TRP:O	1:C:71:THR:HB	2.05	0.55
1:D:200:LEU:HD22	1:D:205:TYR:CD2	2.42	0.55
1:B:111:GLN:CD	1:B:111:GLN:N	2.60	0.55
1:D:134:ILE:HD12	1:D:138:LYS:HD2	1.89	0.55
1:B:111:GLN:CG	1:B:112:ASP:N	2.69	0.55
1:A:119:ASP:OD2	1:A:171:ASP:OD1	2.25	0.54
1:A:38:CYS:SG	5:A:306:GSH:SG2	2.80	0.54
1:D:236:GLU:O	1:D:240:LYS:HB2	2.07	0.54

Continued on next page...

Continued from previous page...

Atom-1	Atom-2	Interatomic distance (Å)	Clash overlap (Å)
1:C:234:PHE:O	1:C:236:GLU:N	2.42	0.53
1:D:48:LEU:HB3	1:D:55:TYR:CE1	2.44	0.53
1:A:18:ARG:N	1:A:21:ASP:OD2	2.26	0.53
1:B:111:GLN:CG	1:B:112:ASP:H	2.22	0.53
1:B:106:ARG:NH2	1:B:174:GLU:HB3	2.24	0.52
1:B:111:GLN:HG2	1:B:112:ASP:H	1.73	0.52
1:D:102:VAL:O	1:D:104:PRO:HD3	2.10	0.52
1:B:47:ALA:O	1:B:51:LYS:HG2	2.09	0.52
1:A:238:TYR:OH	7:A:480:HOH:O	2.16	0.52
1:D:23:LEU:HD12	1:D:24:PRO:HD2	1.90	0.52
1:A:151:TYR:CZ	1:A:155:LEU:HD11	2.45	0.52
1:D:51:LYS:NZ	1:D:103:TYR:O	2.39	0.51
1:D:240:LYS:HB3	1:D:242:GLU:HG3	1.92	0.51
1:C:71:THR:HG22	1:C:72:LYS:HE2	1.92	0.51
1:A:38:CYS:HG	5:A:306:GSH:CB2	2.21	0.51
1:A:201:GLU:OE1	1:A:203:SER:OG	2.17	0.51
1:D:143:VAL:HG12	1:D:144:ASN:N	2.26	0.50
1:A:63:ILE:HG13	1:A:244:PRO:HD2	1.94	0.50
1:C:235:HIS:NE2	7:C:403:HOH:O	2.21	0.50
1:C:149:ALA:O	1:C:153:LYS:HD3	2.11	0.50
1:D:103:TYR:HA	1:D:105:LYS:HZ1	1.77	0.50
1:B:30:LEU:HD23	1:B:31:ARG:N	2.27	0.49
1:A:151:TYR:O	1:A:154:ALA:HB3	2.13	0.49
1:A:171:ASP:HB3	4:A:305:PEG:C3	2.37	0.49
1:D:140:SER:HG	1:D:197:ARG:HH12	1.53	0.49
1:D:90:TYR:O	1:D:91:GLU:HB2	2.13	0.49
1:A:130:GLN:HG2	1:A:185:TRP:CE2	2.48	0.48
1:C:175:PRO:HA	1:C:179:ASP:OD2	2.14	0.48
1:B:135:LYS:HE3	1:B:147:HIS:CD2	2.49	0.48
1:A:91:GLU:O	1:A:95:THR:HG23	2.14	0.48
1:A:153:LYS:NZ	7:A:429:HOH:O	2.37	0.48
1:C:51:LYS:HD3	1:C:53:ILE:HD11	1.96	0.48
1:A:35:MET:HG3	1:A:38:CYS:HB2	1.96	0.47
1:B:208:LEU:HD12	1:B:208:LEU:HA	1.54	0.47
1:C:67:GLU:HG2	3:C:305:EDO:O1	2.15	0.47
1:C:75:PHE:HB2	7:C:417:HOH:O	2.15	0.47
1:C:130:GLN:HG2	1:C:185:TRP:CE2	2.50	0.47
1:C:237:ALA:HB1	1:C:242:GLU:O	2.15	0.47
1:C:201:GLU:OE1	1:C:203:SER:HB3	2.15	0.47
1:B:10:ILE:HD12	7:B:502:HOH:O	2.14	0.46
1:D:106:ARG:NH1	1:D:175:PRO:O	2.45	0.46

Continued on next page...

Continued from previous page...

Atom-1	Atom-2	Interatomic distance (Å)	Clash overlap (Å)
1:A:29:LYS:HE2	1:B:194:HIS:HD2	1.79	0.46
1:A:174:GLU:CB	4:A:305:PEG:H12	2.45	0.46
1:D:47:ALA:O	1:D:51:LYS:HG2	2.15	0.46
1:B:90:TYR:O	1:B:91:GLU:HB2	2.16	0.46
1:D:34:ASN:ND2	1:D:59:ASN:OD1	2.49	0.46
1:D:63:ILE:HG13	1:D:244:PRO:HD2	1.98	0.46
1:D:67:GLU:H	1:D:67:GLU:CD	2.19	0.46
1:B:98:TYR:CZ	1:B:102:VAL:HG21	2.52	0.45
1:C:23:LEU:HD12	1:C:24:PRO:HD2	1.98	0.45
1:C:151:TYR:CZ	1:C:155:LEU:HD11	2.51	0.45
1:C:178:ALA:O	1:C:182:ILE:HG12	2.15	0.45
1:B:119:ASP:OD2	1:B:171:ASP:OD1	2.34	0.45
1:A:10:ILE:HD12	3:A:304:EDO:C2	2.46	0.45
1:A:174:GLU:HB2	4:A:305:PEG:H12	1.97	0.45
1:D:24:PRO:HA	1:D:25:PRO:HD2	1.85	0.45
1:A:133:PHE:HD2	1:A:192:PHE:CE2	2.34	0.45
1:D:112:ASP:HB3	1:D:115:LYS:HG3	1.98	0.44
1:D:134:ILE:HD13	1:D:134:ILE:HA	1.80	0.44
1:B:135:LYS:HE3	1:B:147:HIS:NE2	2.32	0.44
1:D:13:ASN:OD1	1:D:249:LEU:HD12	2.18	0.44
1:B:168:VAL:O	3:B:303:EDO:H21	2.18	0.44
1:D:159:GLN:OE1	1:D:205:TYR:HA	2.17	0.44
1:C:31:ARG:O	1:C:81:ILE:HA	2.18	0.44
1:C:38:CYS:SG	5:C:306:GSH:SG2	2.97	0.44
1:C:133:PHE:HZ	1:C:189:LEU:HG	1.83	0.44
1:B:127:ALA:HB3	1:B:128:PRO:HD3	2.00	0.44
1:C:167:THR:HG21	1:C:172:GLY:HA2	1.98	0.44
1:A:10:ILE:HD12	3:A:304:EDO:H21	2.00	0.44
1:C:26:PHE:CZ	1:C:29:LYS:O	2.70	0.43
1:D:9:ASN:O	1:D:9:ASN:ND2	2.51	0.43
1:B:19:LYS:HG3	1:B:67:GLU:OE1	2.18	0.43
1:B:144:ASN:HB2	1:B:147:HIS:H	1.83	0.43
1:D:144:ASN:O	1:D:148:VAL:HG23	2.19	0.43
1:D:47:ALA:O	1:D:51:LYS:CG	2.67	0.43
1:B:63:ILE:HB	1:B:243:ARG:NH2	2.34	0.43
1:B:139:PHE:CE2	7:B:523:HOH:O	2.57	0.43
1:D:175:PRO:HB2	1:D:180:TYR:CZ	2.54	0.43
1:D:98:TYR:CZ	1:D:102:VAL:HG21	2.54	0.42
1:D:126:SER:HB3	1:D:182:ILE:HG22	2.01	0.42
1:D:65:LYS:HE3	7:D:419:HOH:O	2.18	0.42
1:D:204:LYS:HD3	1:D:205:TYR:CE2	2.54	0.42

Continued on next page...

Continued from previous page...

Atom-1	Atom-2	Interatomic distance (Å)	Clash overlap (Å)
1:A:173:SER:HB2	7:A:507:HOH:O	2.19	0.42
1:D:230:ILE:HG21	1:D:249:LEU:HD21	2.02	0.42
1:C:177:TYR:O	1:C:181:MET:HG2	2.18	0.42
1:C:98:TYR:CZ	1:C:102:VAL:HG21	2.54	0.42
1:C:169:PHE:CE2	1:C:175:PRO:HD3	2.54	0.42
1:D:130:GLN:HG2	1:D:185:TRP:CE2	2.54	0.42
1:D:118:LEU:HD12	1:D:118:LEU:HA	1.87	0.42
1:B:136:ILE:O	1:B:140:SER:HB2	2.20	0.42
1:D:126:SER:CB	1:D:182:ILE:HG22	2.50	0.42
1:D:167:THR:HG21	1:D:172:GLY:HA2	2.02	0.42
1:D:70:THR:HA	1:D:73:SER:O	2.20	0.41
1:D:190:ARG:NE	1:D:216:LEU:HD11	2.35	0.41
1:C:37:TYR:CD1	1:C:226:ILE:HD13	2.55	0.41
1:B:130:GLN:HG2	1:B:185:TRP:CE2	2.55	0.41
1:C:137:LEU:CD1	1:C:192:PHE:HZ	2.33	0.41
1:C:139:PHE:O	1:C:142:THR:OG1	2.36	0.41
1:B:157:PHE:O	1:B:161:GLN:HG2	2.20	0.41
1:D:40:TYR:O	1:D:43:ARG:HB2	2.20	0.41
1:B:15:LYS:HD3	1:B:17:LEU:HD23	2.02	0.41
1:B:193:ALA:O	1:B:199:ARG:HG3	2.21	0.41
1:C:72:LYS:NZ	3:C:304:EDO:H22	2.35	0.41
1:D:125:ALA:O	1:D:128:PRO:HD2	2.20	0.41
1:A:21:ASP:HA	1:A:22:PRO:HD3	1.93	0.41
1:B:70:THR:HA	1:B:73:SER:O	2.21	0.41
1:D:118:LEU:HD12	1:D:121:ILE:HD12	2.03	0.41
1:D:126:SER:HG	1:D:130:GLN:HE21	1.66	0.41
1:A:127:ALA:HB3	1:A:128:PRO:HD3	2.03	0.41
1:C:157:PHE:O	1:C:161:GLN:HG2	2.21	0.41
1:D:90:TYR:CD1	1:D:90:TYR:N	2.89	0.41
1:C:147:HIS:CD2	1:C:147:HIS:N	2.89	0.40
1:D:144:ASN:HB2	1:D:147:HIS:ND1	2.36	0.40
1:A:201:GLU:HA	1:A:202:PRO:HD3	1.83	0.40
1:D:45:ILE:HG21	1:D:224:TYR:CD1	2.57	0.40
1:C:237:ALA:HA	1:C:242:GLU:HG3	2.02	0.40
1:C:198:VAL:HG12	1:C:198:VAL:O	2.22	0.40
1:D:179:ASP:OD1	1:D:211:TYR:OH	2.23	0.40
1:D:201:GLU:HA	1:D:202:PRO:HD3	1.93	0.40

There are no symmetry-related clashes.

5.3 Torsion angles [i](#)

5.3.1 Protein backbone [i](#)

In the following table, the Percentiles column shows the percent Ramachandran outliers of the chain as a percentile score with respect to all X-ray entries followed by that with respect to entries of similar resolution.

The Analysed column shows the number of residues for which the backbone conformation was analysed, and the total number of residues.

Mol	Chain	Analysed	Favoured	Allowed	Outliers	Percentiles	
1	A	240/256 (94%)	233 (97%)	7 (3%)	0	100	100
1	B	239/256 (93%)	229 (96%)	9 (4%)	1 (0%)	34	54
1	C	239/256 (93%)	219 (92%)	14 (6%)	6 (2%)	5	8
1	D	240/256 (94%)	220 (92%)	19 (8%)	1 (0%)	34	54
All	All	958/1024 (94%)	901 (94%)	49 (5%)	8 (1%)	19	35

All (8) Ramachandran outliers are listed below:

Mol	Chain	Res	Type
1	C	240	LYS
1	C	111	GLN
1	C	144	ASN
1	C	235	HIS
1	D	240	LYS
1	C	137	LEU
1	B	199	ARG
1	C	143	VAL

5.3.2 Protein sidechains [i](#)

In the following table, the Percentiles column shows the percent sidechain outliers of the chain as a percentile score with respect to all X-ray entries followed by that with respect to entries of similar resolution.

The Analysed column shows the number of residues for which the sidechain conformation was analysed, and the total number of residues.

Mol	Chain	Analysed	Rotameric	Outliers	Percentiles	
1	A	218/231 (94%)	209 (96%)	9 (4%)	30	55
1	B	217/231 (94%)	205 (94%)	12 (6%)	21	41

Continued on next page...

Continued from previous page...

Mol	Chain	Analysed	Rotameric	Outliers	Percentiles	
1	C	217/231 (94%)	201 (93%)	16 (7%)	13	27
1	D	218/231 (94%)	200 (92%)	18 (8%)	11	22
All	All	870/924 (94%)	815 (94%)	55 (6%)	18	34

All (55) residues with a non-rotameric sidechain are listed below:

Mol	Chain	Res	Type
1	A	9	ASN
1	A	15	LYS
1	A	35	MET
1	A	52	GLN
1	A	71	THR
1	A	118	LEU
1	A	133	PHE
1	A	142	THR
1	A	173	SER
1	B	14	THR
1	B	15	LYS
1	B	29	LYS
1	B	67	GLU
1	B	71	THR
1	B	111	GLN
1	B	118	LEU
1	B	139	PHE
1	B	153	LYS
1	B	199	ARG
1	B	208	LEU
1	B	233	LYS
1	C	27	ASN
1	C	35	MET
1	C	90	TYR
1	C	116	LYS
1	C	118	LEU
1	C	134	ILE
1	C	137	LEU
1	C	140	SER
1	C	142	THR
1	C	146	GLU
1	C	189	LEU
1	C	194	HIS
1	C	203	SER

Continued on next page...

Continued from previous page...

Mol	Chain	Res	Type
1	C	231	LEU
1	C	239	THR
1	C	241	LYS
1	D	29	LYS
1	D	35	MET
1	D	85	GLU
1	D	90	TYR
1	D	105	LYS
1	D	118	LEU
1	D	126	SER
1	D	133	PHE
1	D	134	ILE
1	D	135	LYS
1	D	139	PHE
1	D	140	SER
1	D	160	GLU
1	D	168	VAL
1	D	174	GLU
1	D	189	LEU
1	D	228	LEU
1	D	240	LYS

Sometimes sidechains can be flipped to improve hydrogen bonding and reduce clashes. All (3) such sidechains are listed below:

Mol	Chain	Res	Type
1	B	111	GLN
1	C	144	ASN
1	C	147	HIS

5.3.3 RNA [i](#)

There are no RNA molecules in this entry.

5.4 Non-standard residues in protein, DNA, RNA chains [i](#)

There are no non-standard protein/DNA/RNA residues in this entry.

5.5 Carbohydrates [i](#)

There are no monosaccharides in this entry.

5.6 Ligand geometry

Of 20 ligands modelled in this entry, 10 are monoatomic - leaving 10 for Mogul analysis.

In the following table, the Counts columns list the number of bonds (or angles) for which Mogul statistics could be retrieved, the number of bonds (or angles) that are observed in the model and the number of bonds (or angles) that are defined in the Chemical Component Dictionary. The Link column lists molecule types, if any, to which the group is linked. The Z score for a bond length (or angle) is the number of standard deviations the observed value is removed from the expected value. A bond length (or angle) with $|Z| > 2$ is considered an outlier worth inspection. RMSZ is the root-mean-square of all Z scores of the bond lengths (or angles).

Mol	Type	Chain	Res	Link	Bond lengths			Bond angles		
					Counts	RMSZ	# Z > 2	Counts	RMSZ	# Z > 2
3	EDO	C	305	-	3,3,3	0.44	0	2,2,2	0.43	0
3	EDO	D	303	-	3,3,3	0.45	0	2,2,2	0.38	0
4	PEG	A	305	-	6,6,6	0.38	0	5,5,5	1.34	0
3	EDO	B	303	-	3,3,3	0.55	0	2,2,2	0.49	0
5	GSH	C	306	-	18,19,19	2.07	4 (22%)	21,24,24	1.39	2 (9%)
3	EDO	A	304	-	3,3,3	0.63	0	2,2,2	0.16	0
5	GSH	D	304	-	18,19,19	2.09	4 (22%)	21,24,24	1.60	4 (19%)
5	GSH	B	304	-	18,19,19	2.03	5 (27%)	21,24,24	1.59	4 (19%)
3	EDO	C	304	-	3,3,3	0.43	0	2,2,2	0.46	0
5	GSH	A	306	-	18,19,19	2.08	5 (27%)	21,24,24	1.59	3 (14%)

In the following table, the Chirals column lists the number of chiral outliers, the number of chiral centers analysed, the number of these observed in the model and the number defined in the Chemical Component Dictionary. Similar counts are reported in the Torsion and Rings columns. '-' means no outliers of that kind were identified.

Mol	Type	Chain	Res	Link	Chirals	Torsions	Rings
3	EDO	C	305	-	-	1/1/1/1	-
3	EDO	D	303	-	-	0/1/1/1	-
4	PEG	A	305	-	-	2/4/4/4	-
3	EDO	B	303	-	-	1/1/1/1	-
5	GSH	C	306	-	-	3/24/24/24	-
3	EDO	A	304	-	-	1/1/1/1	-
5	GSH	D	304	-	-	2/24/24/24	-
5	GSH	B	304	-	-	2/24/24/24	-
3	EDO	C	304	-	-	0/1/1/1	-
5	GSH	A	306	-	-	3/24/24/24	-

All (18) bond length outliers are listed below:

Mol	Chain	Res	Type	Atoms	Z	Observed(Å)	Ideal(Å)
5	C	306	GSH	CD1-N2	5.02	1.44	1.34
5	D	304	GSH	CD1-N2	5.00	1.44	1.34
5	B	304	GSH	C2-N3	4.95	1.45	1.33
5	A	306	GSH	C2-N3	4.91	1.45	1.33
5	D	304	GSH	C2-N3	4.63	1.44	1.33
5	A	306	GSH	CD1-N2	4.52	1.43	1.34
5	B	304	GSH	CD1-N2	4.51	1.43	1.34
5	C	306	GSH	C2-N3	4.34	1.43	1.33
5	A	306	GSH	CB2-CA2	-3.59	1.49	1.53
5	D	304	GSH	CB2-CA2	-3.38	1.49	1.53
5	C	306	GSH	CB2-CA2	-3.36	1.49	1.53
5	B	304	GSH	CB2-CA2	-3.16	1.49	1.53
5	C	306	GSH	CB2-SG2	-2.79	1.75	1.81
5	A	306	GSH	CB2-SG2	-2.63	1.76	1.81
5	D	304	GSH	CB2-SG2	-2.59	1.76	1.81
5	A	306	GSH	O11-C1	2.32	1.29	1.22
5	B	304	GSH	CB2-SG2	-2.27	1.76	1.81
5	B	304	GSH	O11-C1	2.17	1.28	1.22

All (13) bond angle outliers are listed below:

Mol	Chain	Res	Type	Atoms	Z	Observed(°)	Ideal(°)
5	A	306	GSH	CA2-CB2-SG2	3.91	118.57	114.16
5	D	304	GSH	CG1-CD1-N2	3.83	122.61	115.86
5	B	304	GSH	CA2-CB2-SG2	3.74	118.38	114.16
5	C	306	GSH	CA2-CB2-SG2	3.72	118.35	114.16
5	D	304	GSH	OE1-CD1-N2	-3.59	116.87	122.95
5	B	304	GSH	OE1-CD1-N2	-2.99	117.89	122.95
5	C	306	GSH	CG1-CD1-N2	2.82	120.84	115.86
5	B	304	GSH	CG1-CD1-N2	2.76	120.73	115.86
5	A	306	GSH	OE1-CD1-N2	-2.74	118.31	122.95
5	D	304	GSH	CA2-N2-CD1	-2.43	115.58	121.68
5	A	306	GSH	CG1-CD1-N2	2.24	119.81	115.86
5	B	304	GSH	CB1-CG1-CD1	2.20	117.97	113.06
5	D	304	GSH	CG1-CB1-CA1	2.16	118.82	113.86

There are no chirality outliers.

All (15) torsion outliers are listed below:

Mol	Chain	Res	Type	Atoms
5	A	306	GSH	O31-C3-CA3-N3
5	A	306	GSH	O32-C3-CA3-N3

Continued on next page...

Continued from previous page...

Mol	Chain	Res	Type	Atoms
4	A	305	PEG	O2-C3-C4-O4
5	C	306	GSH	CA1-CB1-CG1-CD1
3	B	303	EDO	O1-C1-C2-O2
5	D	304	GSH	CA1-CB1-CG1-CD1
3	A	304	EDO	O1-C1-C2-O2
3	C	305	EDO	O1-C1-C2-O2
4	A	305	PEG	C4-C3-O2-C2
5	D	304	GSH	N2-CA2-CB2-SG2
5	C	306	GSH	O12-C1-CA1-N1
5	C	306	GSH	C3-CA3-N3-C2
5	A	306	GSH	O12-C1-CA1-N1
5	B	304	GSH	O12-C1-CA1-N1
5	B	304	GSH	O11-C1-CA1-N1

There are no ring outliers.

9 monomers are involved in 22 short contacts:

Mol	Chain	Res	Type	Clashes	Symm-Clashes
3	C	305	EDO	2	0
4	A	305	PEG	5	0
3	B	303	EDO	1	0
5	C	306	GSH	2	0
3	A	304	EDO	2	0
5	D	304	GSH	3	0
5	B	304	GSH	2	0
3	C	304	EDO	2	0
5	A	306	GSH	3	0

The following is a two-dimensional graphical depiction of Mogul quality analysis of bond lengths, bond angles, torsion angles, and ring geometry for all instances of the Ligand of Interest. In addition, ligands with molecular weight > 250 and outliers as shown on the validation Tables will also be included. For torsion angles, if less than 5% of the Mogul distribution of torsion angles is within 10 degrees of the torsion angle in question, then that torsion angle is considered an outlier. Any bond that is central to one or more torsion angles identified as an outlier by Mogul will be highlighted in the graph. For rings, the root-mean-square deviation (RMSD) between the ring in question and similar rings identified by Mogul is calculated over all ring torsion angles. If the average RMSD is greater than 60 degrees and the minimal RMSD between the ring in question and any Mogul-identified rings is also greater than 60 degrees, then that ring is considered an outlier. The outliers are highlighted in purple. The color gray indicates Mogul did not find sufficient equivalents in the CSD to analyse the geometry.

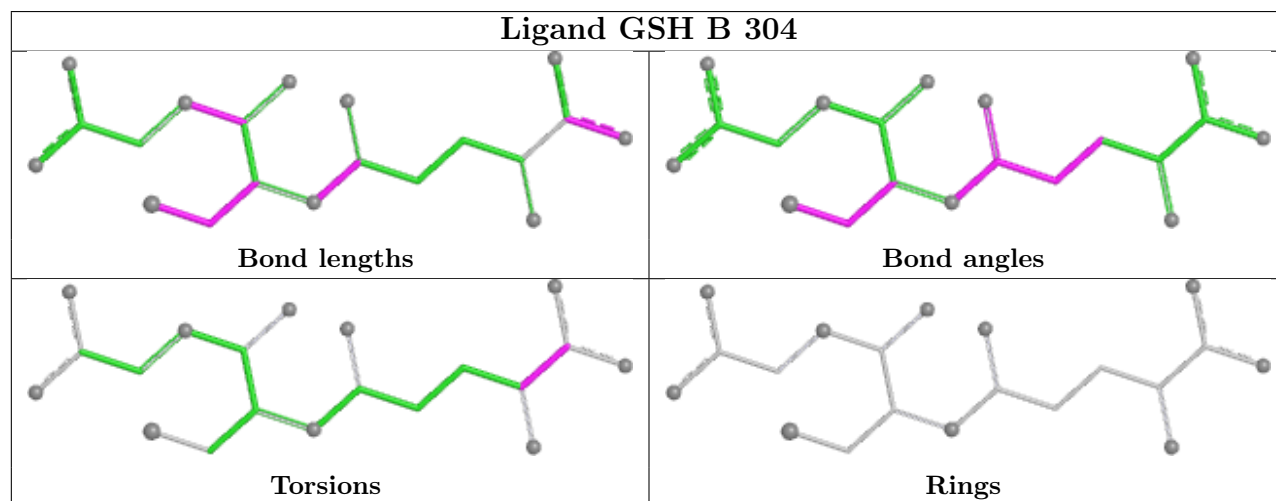
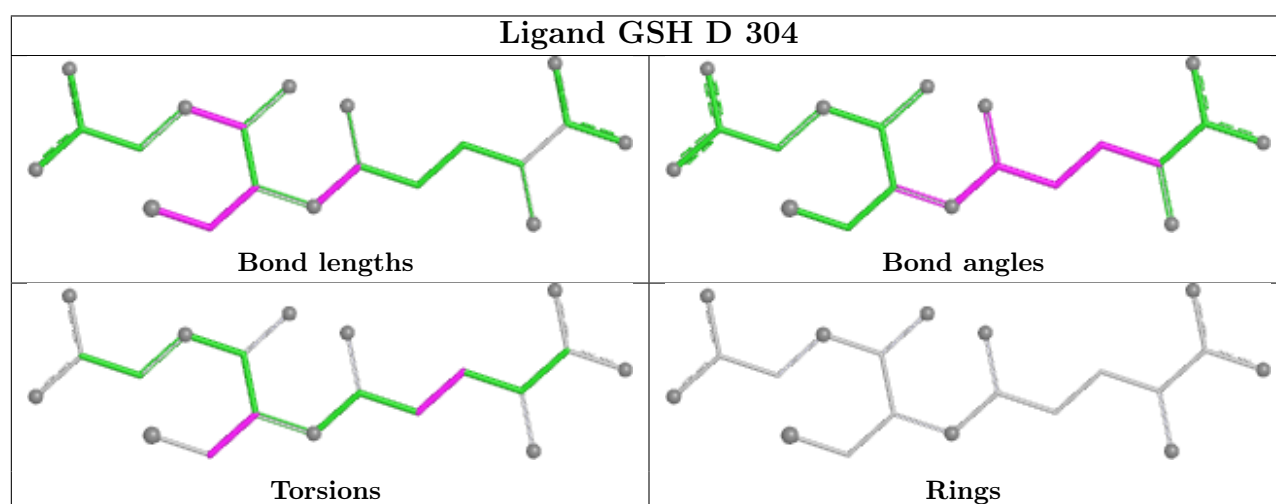
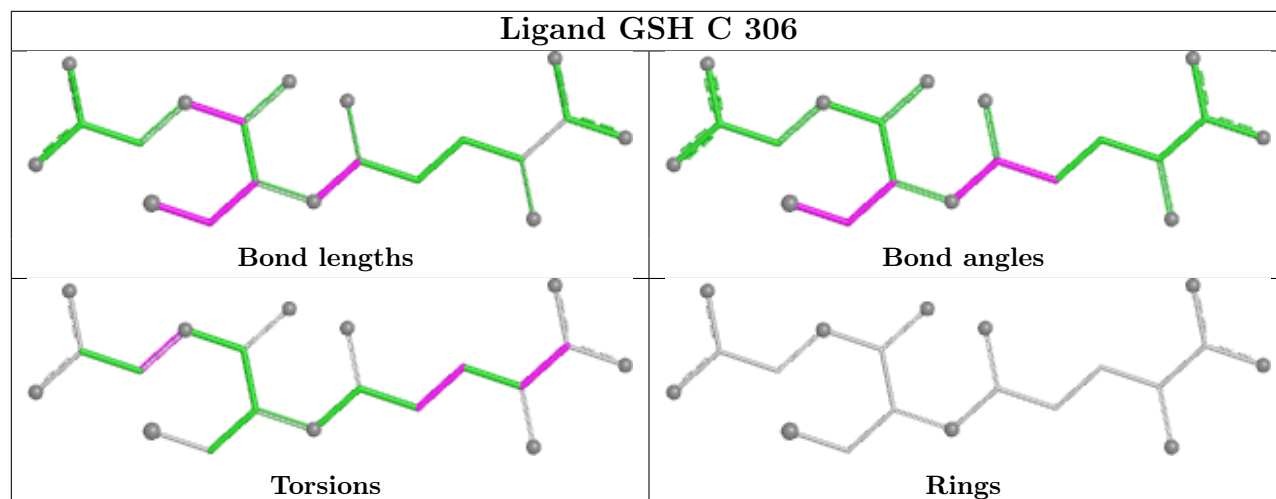

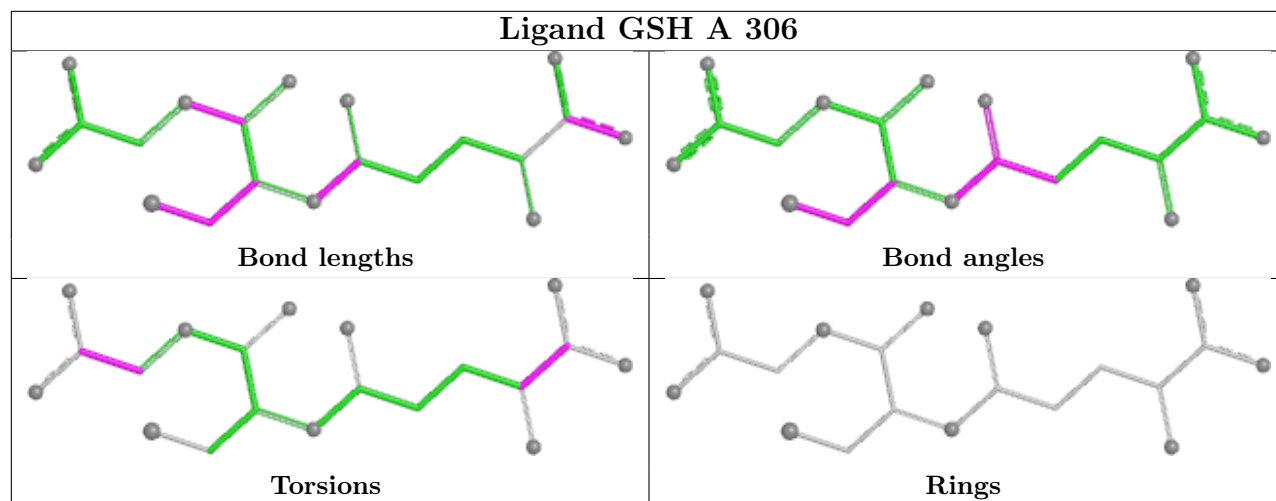

5.7 Other polymers [i](#)

There are no such residues in this entry.

5.8 Polymer linkage issues [i](#)

There are no chain breaks in this entry.

6 Fit of model and data

6.1 Protein, DNA and RNA chains

In the following table, the column labelled ‘#RSRZ > 2’ contains the number (and percentage) of RSRZ outliers, followed by percent RSRZ outliers for the chain as percentile scores relative to all X-ray entries and entries of similar resolution. The OWAB column contains the minimum, median, 95th percentile and maximum values of the occupancy-weighted average B-factor per residue. The column labelled ‘Q < 0.9’ lists the number of (and percentage) of residues with an average occupancy less than 0.9.

Mol	Chain	Analysed	<RSRZ>	#RSRZ>2	OWAB(Å ²)	Q<0.9
1	A	242/256 (94%)	-0.08	5 (2%) 63 66	16, 26, 55, 67	0
1	B	241/256 (94%)	-0.10	4 (1%) 70 72	16, 27, 50, 66	0
1	C	241/256 (94%)	0.49	23 (9%) 8 8	25, 51, 84, 93	0
1	D	242/256 (94%)	0.42	18 (7%) 14 15	26, 48, 74, 84	0
All	All	966/1024 (94%)	0.18	50 (5%) 27 29	16, 37, 74, 93	0

All (50) RSRZ outliers are listed below:

Mol	Chain	Res	Type	RSRZ
1	D	142	THR	5.0
1	D	139	PHE	5.0
1	C	142	THR	4.6
1	C	144	ASN	4.3
1	C	196	GLU	4.1
1	C	193	ALA	3.9
1	C	141	ASP	3.8
1	C	238	TYR	3.5
1	D	204	LYS	3.4
1	A	143	VAL	3.4
1	B	141	ASP	3.2
1	D	166	GLY	3.2
1	D	141	ASP	3.1
1	C	139	PHE	3.1
1	C	192	PHE	3.0
1	D	203	SER	3.0
1	C	194	HIS	3.0
1	C	143	VAL	2.9
1	D	169	PHE	2.8
1	D	137	LEU	2.8
1	B	142	THR	2.7

Continued on next page...

Continued from previous page...

Mol	Chain	Res	Type	RSRZ
1	D	196	GLU	2.7
1	D	201	GLU	2.6
1	D	150	ALA	2.6
1	D	143	VAL	2.6
1	C	203	SER	2.6
1	B	239	THR	2.5
1	B	139	PHE	2.5
1	C	189	LEU	2.5
1	C	250	ASN	2.5
1	C	199	ARG	2.5
1	A	142	THR	2.5
1	C	164	ASN	2.5
1	C	211	TYR	2.5
1	A	141	ASP	2.5
1	D	145	GLU	2.5
1	C	235	HIS	2.4
1	D	26	PHE	2.4
1	A	239	THR	2.4
1	C	145	GLU	2.3
1	D	229	GLU	2.3
1	C	146	GLU	2.3
1	C	41	ALA	2.1
1	D	93	LEU	2.1
1	D	208	LEU	2.1
1	D	164	ASN	2.0
1	C	166	GLY	2.0
1	C	229	GLU	2.0
1	A	19	LYS	2.0
1	C	134	ILE	2.0

6.2 Non-standard residues in protein, DNA, RNA chains [i](#)

There are no non-standard protein/DNA/RNA residues in this entry.

6.3 Carbohydrates [i](#)

There are no monosaccharides in this entry.

6.4 Ligands

In the following table, the Atoms column lists the number of modelled atoms in the group and the number defined in the chemical component dictionary. The B-factors column lists the minimum, median, 95th percentile and maximum values of B factors of atoms in the group. The column labelled 'Q< 0.9' lists the number of atoms with occupancy less than 0.9.

Mol	Type	Chain	Res	Atoms	RSCC	RSR	B-factors(Å ²)	Q<0.9
2	K	C	303	1/1	0.64	0.34	100,100,100,100	0
2	K	A	302	1/1	0.66	0.37	102,102,102,102	0
2	K	A	303	1/1	0.81	0.13	69,69,69,69	0
3	EDO	C	305	4/4	0.85	0.30	45,45,49,54	0
5	GSH	B	304	20/20	0.88	0.18	20,30,48,51	0
4	PEG	A	305	7/7	0.89	0.21	26,30,33,33	0
3	EDO	C	304	4/4	0.90	0.24	48,49,49,60	0
3	EDO	B	303	4/4	0.90	0.18	22,26,30,37	0
5	GSH	C	306	20/20	0.90	0.23	28,32,47,52	0
5	GSH	D	304	20/20	0.91	0.19	26,31,45,52	0
5	GSH	A	306	20/20	0.93	0.16	17,25,43,45	0
3	EDO	A	304	4/4	0.93	0.22	31,33,33,37	0
2	K	D	302	1/1	0.94	0.10	69,69,69,69	0
3	EDO	D	303	4/4	0.96	0.15	49,52,56,59	0
2	K	C	302	1/1	0.96	0.28	56,56,56,56	0
6	IOD	D	301	1/1	0.97	0.05	88,88,88,88	0
6	IOD	C	301	1/1	0.98	0.07	52,52,52,52	0
2	K	A	301	1/1	0.98	0.21	36,36,36,36	0
2	K	B	302	1/1	0.99	0.23	21,21,21,21	0
2	K	B	301	1/1	0.99	0.22	25,25,25,25	0

The following is a graphical depiction of the model fit to experimental electron density of all instances of the Ligand of Interest. In addition, ligands with molecular weight > 250 and outliers as shown on the geometry validation Tables will also be included. Each fit is shown from different orientation to approximate a three-dimensional view.

Electron density around GSH B 304:

$2mF_o-DF_c$ (at 0.7 rmsd) in gray
 mF_o-DF_c (at 3 rmsd) in purple (negative)
and green (positive)

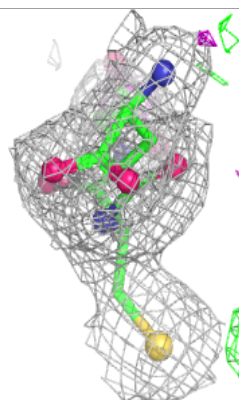
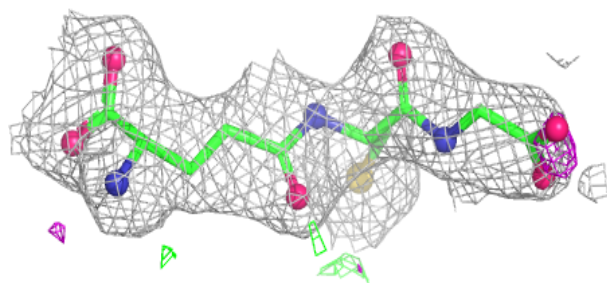
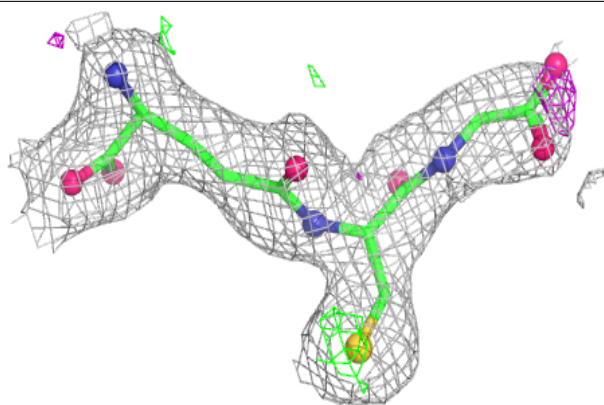
**Electron density around GSH C 306:**

$2mF_o-DF_c$ (at 0.7 rmsd) in gray
 mF_o-DF_c (at 3 rmsd) in purple (negative)
and green (positive)

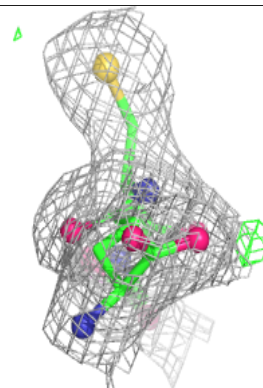
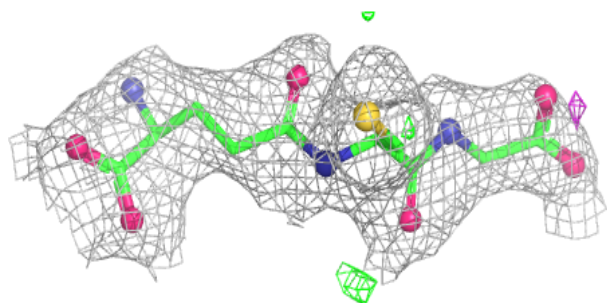
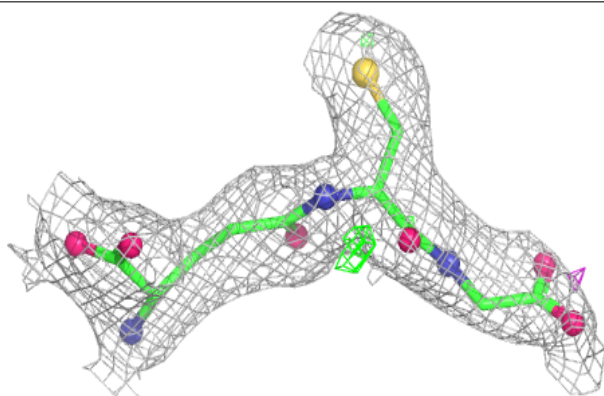

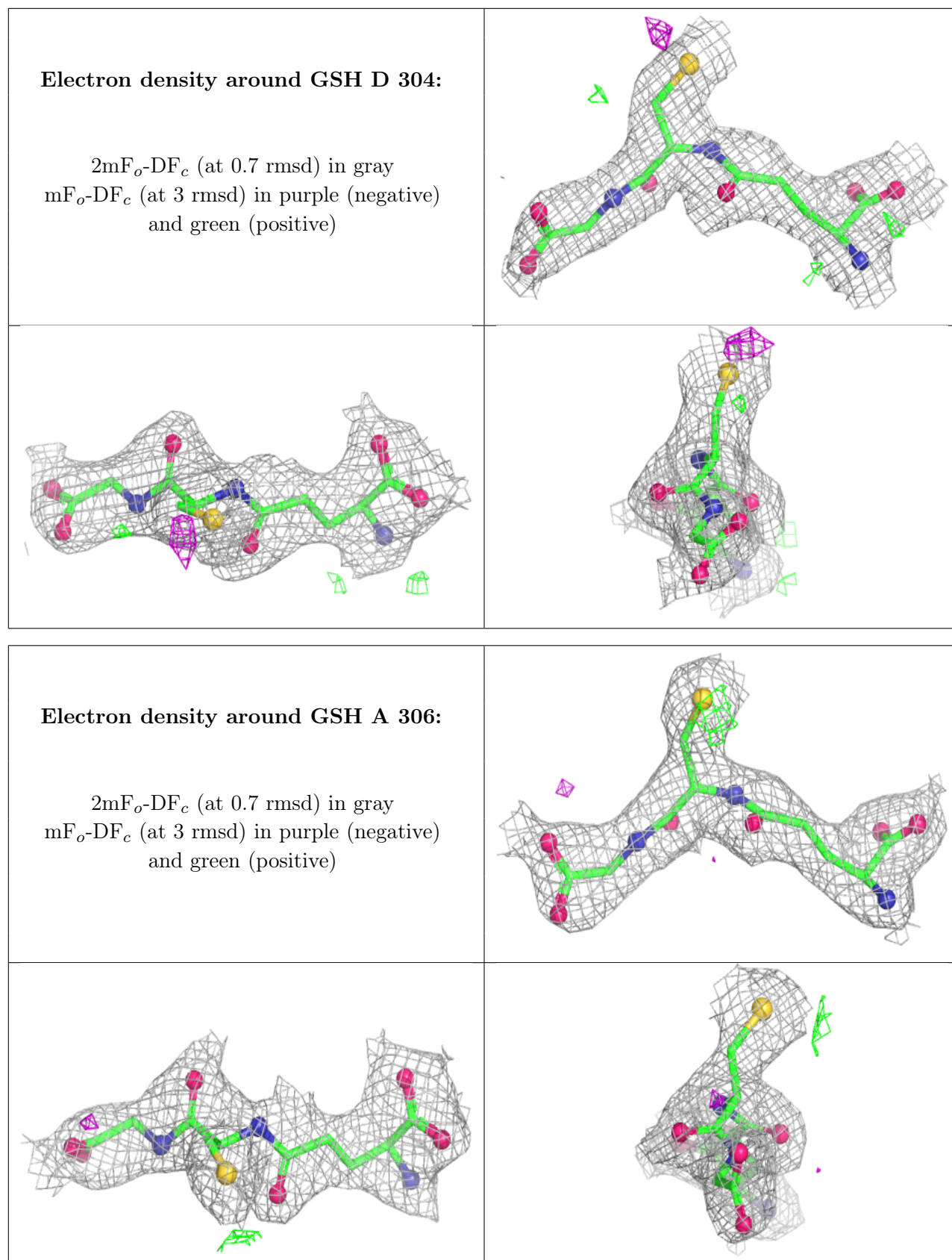

6.5 Other polymers [i](#)

There are no such residues in this entry.